



AUTOMATE™

A DIVISION OF ROLLEASE ACMEDA

Manual Shade Retrofit Guide

CONTENTS

SECTION A OVERVIEW	3
OVERVIEW/OBJECTIVE	3
APPROACH.....	3
KEY CONSIDERATIONS	3
RETROFIT ASSESSMENT KIT	3
PHASE I	4
SECTION B ROLLERS	5
1. PREPARE SHADE FOR INSPECTION	5
2. IDENTIFY THE TUBE	5
2A. TUBE IS NOT ROLLEASE	5
3. SELECT THE RIGHT SIZE MOTOR	6
4. SELECT BRACKET ADAPTER, CROWNS AND DRIVES	6
SECTION C CELLULAR	7
1. PREPARE SHADE FOR INSPECTION	7
2. IDENTIFY THE HEADRAIL AND SHAFT	7
3. IDENTIFY LIFT SYSTEM	8
4. SELECT THE PROPER MOTOR	8
5. SELECT SHAFT AND MOTOR ADAPTERS	8
SECTION D HORIZONTAL BLINDS	9
1. PREPARE SHADE FOR INSPECTION	9
2. IDENTIFY THE HEADRAIL AND SHAFT	9
3. SELECT THE PROPER MOTOR	10
4. SELECT SHAFT AND MOTOR ADAPTERS	10
SECTION E ROMANS	11
1. PREPARE SHADE FOR INSPECTION	11
2. IDENTIFY SPACE	11
3. CLIPS	11
4. SELECT THE RIGHT SIZE MOTOR	11
5. SELECT CROWNS AND DRIVES	12
6. CHECKLIST: ASSESS THE SHADE	13
7. PLANNING THE RETROFIT/ORDERING PARTS	14
8. RETROFIT IMPLEMENTATION	16
9. CELLULAR CORD LIFT GRID - SPRINGS WINDOW FASHIONS	17
10. LIFTING CAPACITY CHART	18
11. TORQUE CALCULATOR	19
12. KNOWN RETROFIT-ABLE SHADE CHART	20

SECTION A | OVERVIEW

OVERVIEW/OBJECTIVE

Motorizing manual window coverings is usually easier than you may think. Whether the shades are brand new or already exist in a home, adding motorization creates a compelling new shade control experience for a homeowner. A shade dealer can also realize considerable financial upside by motorizing shades themselves. Our objective here in this document is to empower shade dealers to retrofit manual shades with motors if they so choose. We are committed to document the mechanics of each shade type and share this information with dealers who choose to motorize shades themselves.

APPROACH

The approach is simple. Three steps:

1. Assess the shade (tube/headrail & brackets)
2. Planning the retrofit/Ordering Parts from Rowley
3. Retrofit the shade

KEY CONSIDERATIONS

- Some retrofits are easier than others. Please read through each retrofit guide in detail. We have tried to document the various shade types and systems as best as possible.
- There are an incredible amount of hardware systems in the field. Many are Rollease or knock offs. There are other vendors with unique tubes and bracketing systems. As we run into them, we will document the retrofit-ability. Many systems are compatible with Rollease motors; some are not. Please qualify each retrofit opportunity to ensure the best chance of success.
- It often makes sense to simply order motorized from the factory. Consider if/when retrofit is right for you and your client.
- Retrofitting manual shades usually voids the original manufacturer's warranty. Please consider this when making the decision to retrofit.

RETROFIT ASSESSMENT KIT

The Retrofit Assessment Kit is everything that you need to start retrofitting your shades in only one sleek box. It contains all the accessories and adapters that you use to retrofit a variety of shades from a manual control to a Automate Motorized system. The box is meant to qualify a retrofit, try out bracket adapters and drives to ensure compatibility with various systems PRIOR to retrofit attempt.

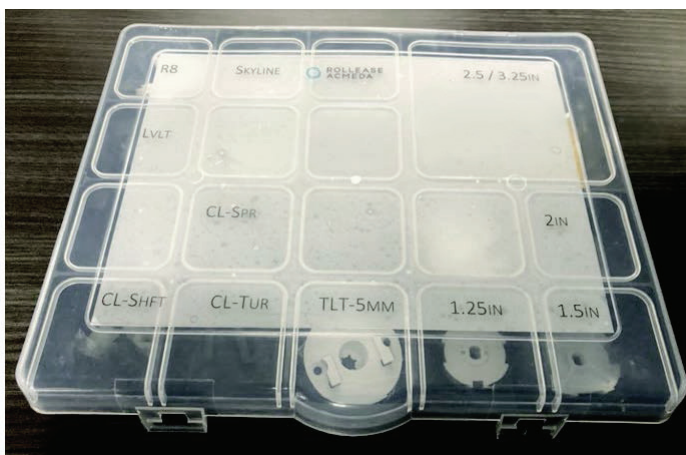

PN: MK02-MT01-000001 - Retrofit Assessment Kit

Kit Content:

Edit - BOM Structure			
Type	Part Number	Description	Qty. per
Kit	MK02-MT01-000001	Retrofit Assessment Kit	1.00
Item	MT03-0207-050016	Cord Lift Motor Adapter for Springs Headrail	1.00
Item	MTAD-CLHR-TUR	Motor Adapt Cord Lift - Turnils Headrail	1.00
Item	MTAD-CLSA-4MMSQ	Shaft Adapt Cord Lift - 4mm Square	1.00
Item	MTAD-CLSA-5MMSQ	Shaft Adapt Cord Lift - 5mm Square	1.00
Item	MTAD-CLSA-D	Shaft Adapt Cord Lift - D Shaft	1.00
Item	MTAD-CLSA-V	Shaft Adapt Cord Lift - V Groove Shaft	1.00
Item	MTAD-TILT-SA-5HEX	Shaft Adapt for Tilt Motor-5MM HEX	1.00
Item	MTDR-25-1.25	Drive for 25mm DC motor in 1.25" tube	1.00
Item	MTDR-25-28-1.5	Drive for 25/28mm DC motor in 1.5" tube	1.00
Item	RTA5LS40	"Adapter Set 2"" Tube for LS40 and ST40 Motors"	1.00
Item	RB24-0163-050001	Drive for 45mm motor in 2.5" & 3.25" tubes	1.00
Item	MT02-0101-069007	BB REMOTE CONTROL ARC 15Ch	1.00
Item	MT03-0205-069001	AUTOMATE BRACKET ADAPTOR R8 SERIES	1.00
Item	MT03-0206-069002	AUTOMATE BRACKET ADAPTOR SKYLINE SERIES	1.00
Item	MT03-0207-069015	AUTOMATE BRACKET ADAPTOR LOUVOLITE SERIES	1.00
Item	MT03-0205-069002	AUTOMATE BRACKET ADAPTOR R16-SERIES	1.00
Item	TM10-0286-000000	Tough Box for Retrofit Assessment Kit	1.00
Item	TM10-0285-000000	Screwdriver for Retrofit Assessment Kit	1.00

PHASE I

This is our first phase of retrofitting. We have focused primarily on motorization of existing shades which use Rollease manual hardware + the most popular shades from other manufacturers (based on feedback from dealers on the front lines). This is a living document and will be updated as new retrofits are encountered and documented. Successful, documented retrofits currently include:

- Solar and Blackout Roller shades
- Cellular/Honeycomb
- Sheer/Shadings/Zebra
- Roman shades
- Venetian Blinds
- Draperies

It is critical that you qualify each shade before initiating a motorization retrofit. Here, we will walk you through the process to identify each shade’s hardware system and it’s retrofit compatibility.

SECTION B | ROLLERS

1. PREPARE SHADE FOR INSPECTION

Measure and note the shade size. Remove the shade from the window. Inspect the shade hardware to determine bracketing system. Refer to images below to identify different bracket systems. Next in a clean space, carefully remove the clutch or the idler from the shade.

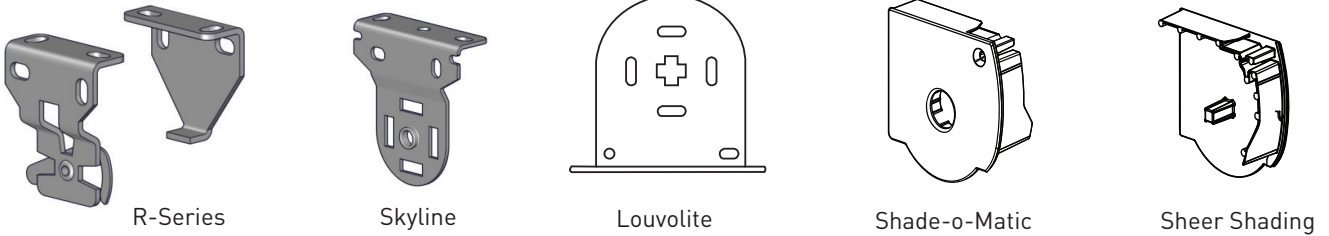

2. IDENTIFY THE TUBE

Many fabricators use/have used standard Rollease tube profiles. Each fabricator has different build guidelines – the chart below identifies typical tube sizes for manual roller shades (measured in feet). Sometimes fabricators will use a 1.5" in lieu of the 1.25" tube - make sure to measure or to size with a loose motor adapter.

	1	2	3	4	5	6	7	8	9	10
1										
2										
3										
4										
5										
6										
7										
8										
9										
10										
1.25" Tube										
1.5" Tube										
2.0" Tube										

1.25" Tube << Use 25mm motor
 1.5" Tube << Use 25mm motor
 2.0" Tube << Use 28mm motor

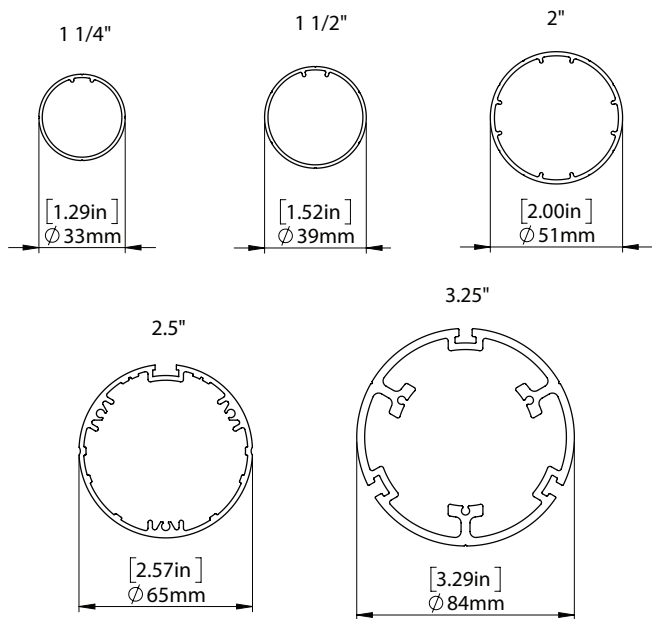

Springs Window Fashions utilizes this chart with Rollease tubes when fabricating manual roller

2A. TUBE IS NOT ROLLEASE

Occasionally, you will run into a third party tube. The adapters in each kit fit a variety of non Rollease tubes - some are direct fits while others may require slight modification. We recommend you carry an adapter kit to check fit in each potential retrofit.

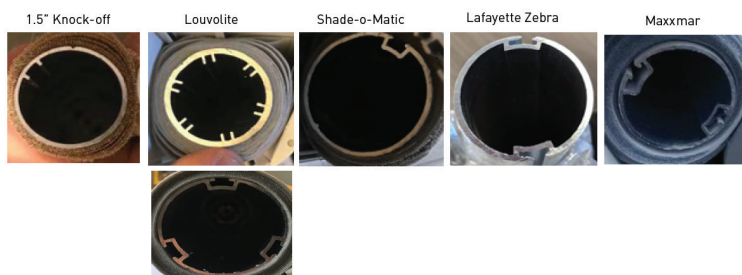

SECTION B | ROLLERS

3. SELECT THE RIGHT SIZE MOTOR

Tube size and shade width play a critical roll in considering motor selection. Generally, we recommend:

- 25mm 1.1 Nm motor for shades up to 7'x7' and a 1.25" or 1.5" tube.
- 28mm 2.0Nm motor for shades up to 10'x10' with a 1.5" or 2.0" tube.

Refer to chart below for a deeper dive into motor selection. (In case of narrow shades <21", use DC motor with rechargeable battery pack)

Motor Type - Per Rowley Order Form	MTDCRF25-1.1 (DC Motor - Short blinds)	REMZDCB-SW25-1.1 (Switch Wand Motor)	MT01-1325-069002	MT01-1328-069001	MT01-1335-069001	MT01-1345-069001
Max Shade Size	84"x84"	84"x84"	84"x84"	120"x120"	120"x120"	144"x144"
Tube Size Options	1.25" and 1.5"	1.25" and 1.5"	1.25" and 1.5"	1.5" and 2.0"	2.0"	2.5" and 3.25"
Width of Motor	11.77"	17.56"	21.93"	25.59"	33.50"	32.04"

4. SELECT BRACKET ADAPTER, CROWNS AND DRIVES

We offer a complete kit for each motor. This will include crowns and drives for each of the "Tube size options" listed in the chart above on Step 3. Additionally, each motor will have a flush mount adapter for the three Rollease bracketing systems (Skyline, R8 and R16) as shown below. (Will come with Skyline attached to motor)

Bracket Adapters



R8
PN: MT03-0205-069001



R16
PN: MT03-0205-069002



SKYLINE
PN: MT03-0206-069002



LOUVOLITE
PN: MT03-0207-069015

Crowns and Drive Examples



25mm - 1.25in
PN: MTCRDR-25-1.25



25mm - 1.5in
PN: MTCRDR-25-1.5



28mm - 1.5in
PN: MTCRDR-28-1.5

SECTION C | CELLULAR

1. PREPARE SHADE FOR INSPECTION

Measure and note the shade size. Remove the shade from the window. Inspect the shade hardware to determine the type of hardware you are working with and follow the below steps.

2. IDENTIFY THE HEADRAIL AND SHAFT

Rollease has developed motor adapters that fit Turnils and SWF Headrails. Refer to charts below to determine what type of headrail you are working with. We also have a variety of shaft adapters for many standards in the industry: Reference 'Shaft Adapter Chart' below.

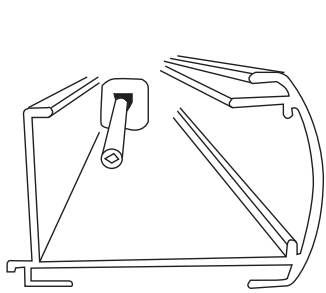

"Turnils" style

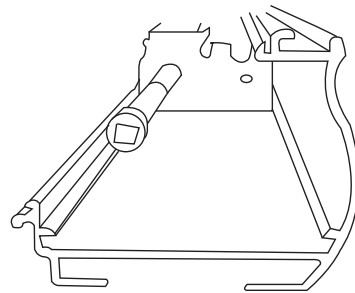

Springs Window Fashions/Horizons

	Turnils Headrail	SWF Headrail	Lafayette Headrail
Headrail Profile			
Motor Cradle	MTAD-CLHR-TUR 	MT03-0207-050016 	MT03-0207-050020

SHAFT ADAPTORS			
V Groove Shaft	D Shaft	5mm Square	4mm Square
PN: MTAD-CLSA-V	PN: MTAD-CLSA-D	PN: MTAD-CLSA-5MMSQ	PN: MTAD-CLSA-4MMSQ

PRO TIP: Pull extra pinion rod from scrapped shades to save for later use

WE DO NOT RECOMMEND MOTORIZING FIBER GLASS ROD AT THIS TIME

3. IDENTIFY LIFT SYSTEM

Spool based systems are the most straight forward cellular retrofit, however CCL retrofits are possible and documented, but take time. If retrofitting new shades in the field, it is prudent to order Cordless shades for the most straight forward retrofit.

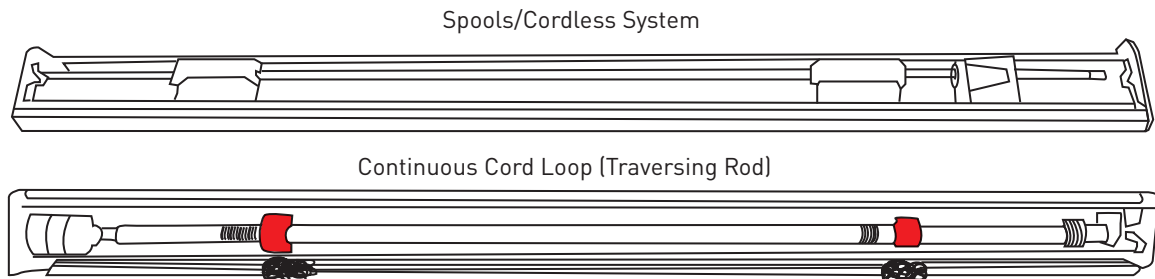

4. SELECT THE PROPER MOTOR

Cord Lift Motors come in two varieties:

- End Mount
- Center Mount

Determine if there is an appropriate amount of space from the end of the headrail to the first drop down to fit an End Mount Motor. If not, use a Center Mount Motor. Reference the diagrams in diagrams below.

NOTE: All Cord Lift Motors are DC and require a battery pack or 12v hardwire to operate.

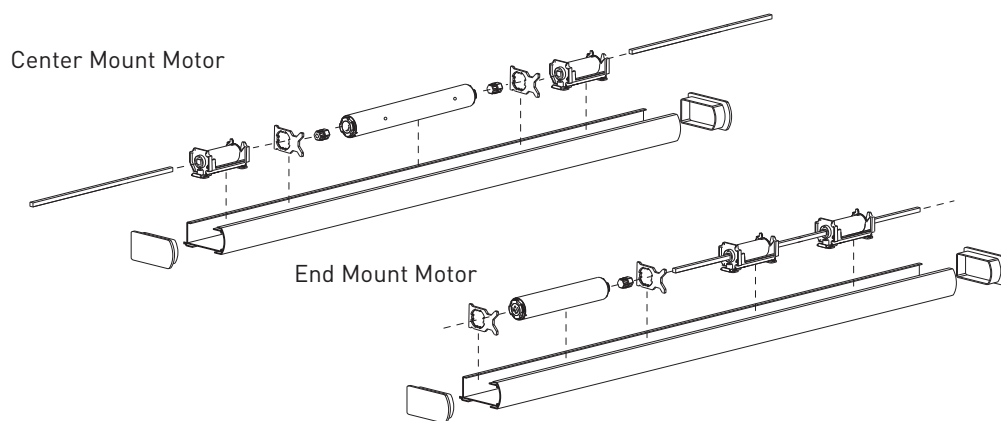

5. SELECT SHAFT AND MOTOR ADAPTERS

The 'Install Kits' that you will order from Rowley will contain all necessary shaft and motor cradles. It includes 2 of each so that you will be prepared for the end mount or center mount motor.

SECTION D | HORIZONTAL BLINDS

1. PREPARE SHADE FOR INSPECTION

- Measure and note the shade size.
- Remove the shade from the window.
- Inspect the shade hardware to determine if there is a minimum of 4.75" from the end of the headrail to the first lifting spool.
- If there is, you can use the end mount motor.
- If not, you can use the through shaft motor.

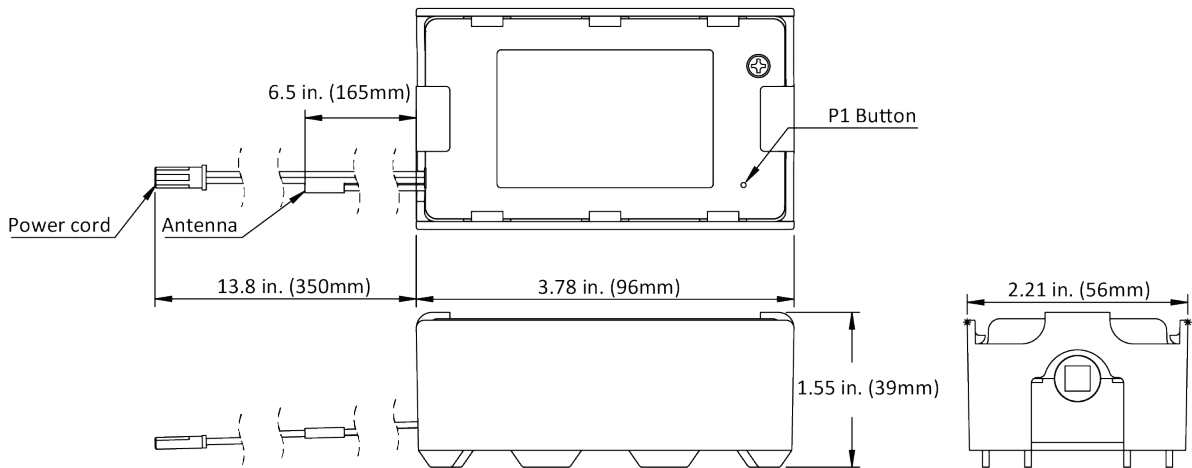

2. IDENTIFY THE HEADRAIL AND SHAFT

Measure the height of the headrail. Reference table below to determine which motor cradle you may need. Look at the shaft style. Reference shaft adaptor table to determine which shaft adapter you may need.

Headrail Profile	<p>1.5in Headrail</p>	<p>2in Headrail</p>
Motor Cradle	<p>Cradle included with Motor</p>	<p>MTAD-TILT-HPCRADLE</p>

SECTION D | HORIZONTAL BLINDS

3. SELECT THE PROPER MOTOR

There is only one Tilt Motor for horizontal blinds.

End Mount Motor



PN: MTDCRF-TILT

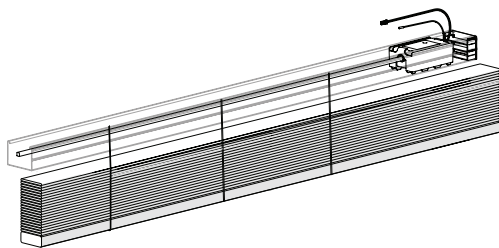

Pass Through Tilt Motor Kit

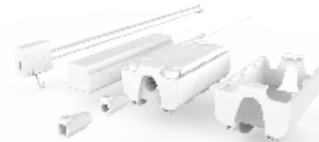

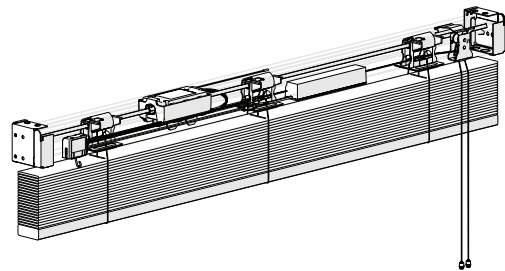

PN: MT01-4001-069002



4. SELECT SHAFT AND MOTOR ADAPTERS

From the above step you will know what motor adapter as well as the appropriate shaft adapter and order accordingly from Rowley.

End Mount Motor

SHAFT ADAPTORS	
MTDCRF-TILT	MTD-TILT-SA-5HEX
	

Pass Through Tilt Motor

SHAFT ADAPTORS
All shaft adapters ship with the kit

SECTION E | ROMANS

1. PREPARE SHADE FOR INSPECTION

Measure and note the shade size and approximate weight. Rowley will be providing a Turn Key system for Romans to aid in the ease of use. There will be just a few factors to take into consideration. If the Roman shade is already on a tube, you can approach this the same way you would a Roller shade.

2. IDENTIFY SPACE

One important consideration with Romans will be if there is enough depth on the headboard for the turn key system that will be installed. It is also important to be precise in your measurements of the width of the shade.

TURN KEY SYSTEM: ROWLEY offers a complete system that includes, brackets, tube, clips, etc.

3. CLIPS

There are a few different systems of clips attaching the lines for romans. Lift Line Clips should be most common but occasionally you may run into ribbon spool as shown in diagram I. Note: Make sure to count the number of clips that are on the blind to be retrofitted. TYPES OF CLIPS: Ribbon Spool on top with Lift Line Clips shown below:



4. SELECT THE RIGHT SIZE MOTOR

Refer to the chart below for a deeper dive into motor selection. (In case of narrow shades <21", use DC motor with rechargeable battery pack)

Tube size and shade width play a critical roll in considering motor selection. Generally, we recommend:
25mm 1.1 Nm motor for shades up to 7'x7' and a 1.25" or 1.5" tube
28mm 2.0Nm motor for shades up to 10'x10' with a 1.5" or 2.0" tube.

Motor Type	MTDCRF25-1.1 (DC Motor - Short blinds)	MTDCBSW25-1.1 (Switch Wand Motor)	MT01-1325- 069002	MT01-1325- 069001	MT01-1335- 069001	MT01-1345- 069001
Max Shade Size	84"x84"	84"x84"	84"x84"	120"x120"	120"x120"	144"x144"
Tube Size Options	1.25" and 1.5"	1.25" and 1.5"	1.25" and 1.5"	1.5" and 2.0"	2.0"	2.5" and 3.25"
Width of Motor	11.77"	17.56"	19.87"	25.60"	33.41"	32.04"
Lifting Capacity	15.6lbs	15.6lbs	15.6lbs	23.6lbs	31.4lbs	31.4lbs

5. SELECT CROWNS AND DRIVES

We offer a complete kit for each motor. This will include crowns and drives for each of the “Tube size options” listed in the chart on the previous page. Additionally each motor will have a flush mount adapter for the three Rollease bracketing systems (Skyline, R8 and R16) as shown in the chart on the previous page. (Will come with Skyline attached to motor)

Bracket Adapters

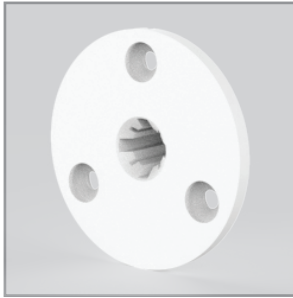

R8

PN: MT03-0205-069001



R16

PN: MT03-0205-069002



SKYLINE

PN: MT03-0206-069001



LOUVOLITE

PN: MT03-0207-069015

Crowns and Drive Examples



25mm - 1.25in
PN: MTCRDR-25-1.25



25mm - 1.5in
PN: MTCRDR-25-1.5



28mm - 1.5in
PN: MTCRDR-28-1.5

6. CHECKLIST: ASSESS THE SHADE

ROLLERS/ROLLER TYPE PRODUCT (TUBULAR MOTOR)

- a) Are the brackets compatible?
 - Skyline
 - R-Series
 - Louvolite
 - Others with known retrofit-ability?
- b) Determine appropriate motor
 - Tube size/profile
 - Size of shade
 - Weight of fabric
 - Torque calculator (for Romans)
- c) Select appropriate Crown and Drive set
 - Based on Motor type and Tube size

HONEYCOMB/CELLULAR (CORD LIFT MOTOR)

- a) Measure headrail space to determine:
 - End Mount Motor
 - Center Mount Motor
- b) Assess headrail profile
 - Select appropriate motor cradle
- c) Assess drive shaft
 - Select appropriate shaft adapter

HORIZONTAL BLINDS (TILT MOTOR)

- a) Is there a minimum 5in from end of head rail on control side to first cradle/drop down
- b) Select appropriate Motor Cradle:
 - Low Profile headrail
 - Tall headrail
- c) Select appropriate Shaft Adapter

ROMANS (TUBULAR MOTOR)

- a) Are brackets Compatible?
 - Ribbon Spool
 - Lift Line Clips
 - Skyline
 - R-Series
 - Order appropriate SLAM adapter
- b) Determine appropriate motor (Torque Calculator)
 - Tube size/profile
 - WxL of shade
 - Weight of fabric
- c) Select appropriate Crown and Drive set
 - Based on Motor type and Tube size

7. PLANNING THE RETROFIT/ORDERING PARTS

Using the checklist from the previous step, you should know if your shade is retrofit-able. If it is, you should have a good understanding of the hardware system you are working with. Below is a guide of which motors/adapters work with each compatible hardware system. TIP: Make sure to select appropriate control devices, chargers, and accessories. This guide focuses on the hardware for the shade only.

ROLLERS/ALL TUBULAR MOTORS

item #	Item Description	Additional Information
MTDCBSW25-1.1	25mm DC Switch Wand Battery Motor, 1.1/40	Switch Wand 25mm Motor (17.6" wide) - Includes 24" White Wand Assembly
MTSW24-W	Wand Assembly for Switch Motor, 24" - White, CT20	
MT01-1325-069002	25mm DCRF Battery Motor, 1.1N/40r	25mm 1.1Nm Rechargeable Battery RF Motor (20" Wide)
MT01-1328-069001	28mm DC RF Quiet Battery Motor, 2N/28r	28mm 2.0 Nm Rechargeable Battery RF Motor - QUIET (25.6" Wide)
MT01-1335-069001	35mm DCRF Battery Motor, 3N/28r	35mm 3.0Nm Rechargeable Battery RF Motor
MT01-1345-069001	45mm DCRF Quiet Motor, 3N/28r 45mm DCRF Quiet Motor, 3N/28r	45mm 3.0Nm Rechargeable Battery RF Motor - QUIET
Install Kit Part Numbers	Note: Order Motor + Install kit to reduce shipping charges	
REMZR25MM-1.1	Install kit for 1.1NM motors - 1.25" and 1.5" tubes	Install kit for 25mm, 1.1Nm motor in 1.25" and 1.5" tubes
REMZR28MM-2.0	Install kit for 2.0NM motor - 1.5" and 2" tubes	Install kit for QUIET 28mm, 2.0Nm motor in 1.5" and 2" tubes
REMZR35MM-3.0	Install kit for 35mm 3.0NM motor - 2" tubes	Install kit for 35mm, 3.0NM motor in 2" tubes
Odd Size/Specialty Crowns and Drives	Please reach out to Rowley for more information	Rollease Acmeda Can help

SECTION E | ROMANS

ROLLERS/ALL TUBULAR MOTORS

item #	Item Description	
MTDCRF-CL-0.6-50	Cord Lift DCRF Motor - 0.6N-50r	.6Nm Cord Lift DC RF Motor for Cellular, Pleated, Headrail Romans -Single Output Shaft for Placement at End of Headrail
MT01-3001-069001	Cord Lift DCRF Motor-0.8N-45rpm, Dual shaft	.8Nm Cord Lift DC RF Motor for Cellular, Pleated, Headrail Romans - Dual Output Shaft for Placement in Middle of Headrail
REMZR-CELLULAR	Install kit for cellular cord lift motor - Turnils style headrail	Install kit for cellular cord lift motor - Turnils style headrail
MT03-0305-069003	Rchrgbl Btry Pak- 28mm DCBRF(no Batt)Mtr 2600mAh	Large Rechargeable Battery Pack for use with all DC motors including Cord Lift (Cellular), Tilt (Venetian Blinds) and 25mm DC motor for narrow shades
REMZR45MM-3.0	Install kit for 45mm 3.0NM motor - 2.5" and 3.0" tubes	Install kit for QUIET 45mm, 3.0Nm motor in 2.5" and 3.25" tubes

HORIZONTAL BLINDS

item #	Item Description	
MTDCRF-TILT-1	Tilt Motor for Venetian Blinds-1N (inc cradle)	Tilt Motor for Venetian Blinds includes Low Profile Cradle and Integrated Mount for 6.6mm Square Shaft
REMZR-BLIND	Install kit for 2" wood blind tilt motor	Install kit for Tilt Motor into High Profile Headrail - Includes 5.6mm Hex Shaft Adapter
MT03-0305-069003	Rchrgbl Btry Pak- 28mm DCBRF(no Batt)Mtr 2600mAh	Large Rechargeable Battery Pack -- for use with all DC motors including Cord Lift (Cellular), Tilt (Venetian Blinds) and 25mm DC motor for narrow shades

DRAPERIES

item #	Item Description	
MTACRFDR-50KGLC	AUTOMATE C [-mm/1.2Nm/14r] ARC-MTR110V-20' cord	A/C Powered Drapery Track Motor -- Moves 110 lb. -- 20' cord.
MTDR-EP-DR-AC	Track End Gear - Pulley for MTACRFDR-50KG	Drapery Track Adapter Kit -- Converts BTX and Somfy Glydea Track to work with Drapery motor

8. RETROFIT IMPLEMENTATION

THIS IS A GENERAL 'HOW TO' GUIDE, PLEASE SEE SHADE SPECIFIC GUIDES FOR GREATER DETAIL

ROLLER/ROMAN/CASSETTE (TUBULAR MOTOR)



- a. Prep Motor
 - Install Crown and Drive
 - Install Bracket Adapter
- b. Prep Shade
 - Remove Shade
 - Remove Clutch
- c. Install Motor
 - Ensure grooves are lined up
- d. Hang shade
- e. Program Motor

HONEYCOMB/CELLULAR/HORIZONTAL BLINDS (CORD LIFT AND TILT MOTOR)

- a. Prep motor
 - Install necessary cradle
 - Install necessary shaft adapter(s)
- b. Prep Shade
 - Remove shade
 - Remove any necessary components
 - Measure and cut shaft as necessary
- c. Install Motor
 - Slide motor into headrail
 - Insert shaft into motor
 - Mount and connect external battery
- d. Pair the motor to the remote
- e. Hang shade
- f. Program motor

9. CELLULAR CORD LIFT GRID - SPRINGS WINDOW

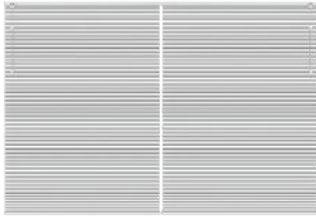
CORD LIFT SHADES

Fabric Styles	Price Group	Maximum Fabric Width (inches)	 Cord Lift Shades				 Cord Lift Multiple Shades on One Headrail					 Cord Lift Bottom Up/Top Down				
			Width		Height		Width			Height		Width		Height		
			Min*	Max	Min	Max	Min Panel*	Max Panel	Max Shade	Min Shade	Max Shade	Min*	Max	Min	Max	
			(Inches)	(Inches)	(Inches)	(Inches)	(Inches)	(Inches)	(Inches)	(Inches)	(Inches)	(Inches)	(Inches)	(Inches)	(Inches)	(Inches)
Celestial	¾" double cell	E	90	9	90	9	144	9	90	192	9	144	9	90	9	96
	¾" single cell	E		9	144	9	144	9	144	192	9	144	9	96	9	96
Clarity	¾" single cell	H	144	9	144	9	144	9	144	192	9	144	9	96	9	96
	¾" single cell	H		9	144	9	144	9	144	192	9	144	9	96	9	96
Columba	¾" double cell	F	86	9	86	9	96	9	86	192	9	96	12	86	12	80
	¾" single cell	F	144	9	144	9	144	9	144	192	9	144	9	96	9	96
Divinity	¾" single cell	H	144	9	144	9	144	9	144	192	9	144	9	96	9	96
Galaxy	¾" double cell	C	120	9	120	9	144	9	120	192	9	144	9	96	9	96
	¾" single cell	C		9	120	9	144	9	120	192	9	144	9	96	9	96
	¾" single cell	C		9	120	9	144	9	120	192	9	144	9	96	9	96
Galaxy II	¾" double cell	E	120	9	120	9	144	9	120	192	9	144	9	96	9	96
	¾" single cell	C		9	120	9	144	9	120	192	9	144	9	96	9	96
	¾" single cell	C		9	120	9	144	9	120	192	9	144	9	96	9	96
Marvel	¾" single cell	G	144	9	144	9	144	9	144	192	9	144	9	96	9	96
	¾" single cell	G		9	144	9	144	9	144	192	9	144	9	96	9	96
Newhall	¾" double cell	E	90	9	90	9	144	9	90	192	9	144	9	90	9	96
Nostalgia	¾" double cell	E	90	9	90	9	144	9	90	192	9	144	9	90	9	96
Obsidian	¾" single cell	D	96	9	96	9	144	9	96	192	9	144	9	96	9	96
Orion	¾" double cell	B	96	9	96	9	144	9	96	192	9	144	9	96	9	96
	¾" single cell	A		9	96	9	144	9	96	192	9	144	9	96	9	96
	¾" single cell	B		9	96	9	144	9	96	192	9	144	9	96	9	96
Seclusion	¾" single cell	F	144	9	144	9	144	9	144	192	9	144	9	96	9	96
	¾" single cell	F		9	144	9	144	9	144	192	9	144	9	96	9	96
Somerset	¾" single cell	D	144	9	144	9	144	9	144	192	9	144	9	96	9	96
Somerset FR	¾" single cell	E	144	9	144	9	144	9	144	192	9	144	9	96	9	96

10. LIFTING CAPACITY CHART

		LIFTING CAPACITY																														
		RA 1"		RA 1-1/8"		RA 1-1/4"		RA 1-1/2"		S45 Light		S45 Standard		S45 Heavy Duty		RA 2" Ribbed		RA 2" Smooth		S40		RA 2-1/2"		RA 3-1/4"		S80						
		lbs	kg	lbs	kg	lbs	kg	lbs	kg	lbs	kg	lbs	kg	lbs	kg	lbs	kg	lbs	kg	lbs	kg	lbs	kg	lbs	kg	lbs	kg	lbs	kg			
Automate™ Mtoro Models	1.10	MTDCBRF25-1.1																														
		MTDCRF25-1.1			15.6	7.1	13.0	5.9	11.5	5.2	11.2	5.1	10.1	4.6																		
		MTDCBSW25-1.1																														
	2.00	MTDCBRFQ28-2					23.6	10.7	20.9	9.5	20.4	9.3	18.4	8.3	17.7	8.0																
		MTDCBRF35-3																														
		MTDCRF35-3							31.4	14.2	30.7	13.9	27.5	12.5	26.6	12.0																
		MTDCBRFQ45-3																														
		MTACRF35-6																														
		MTACRF35-6LC							62.7	28.5	61.3	27.8	55.1	25.0	53.1	24.1																
		MTACML35-6																														
6.00	MTDCBRF45-10																															
	MTDCRF45-10																															
	MTACQRF45-10																															
	MTACQRF45-10LC																															
	MTACQ45-10-M																															
15.00	MTACRF45-15																															
20.00	MTAC45-20-M																															

11. TORQUE CALCULATOR

1. GO TO: [HTTPS://WWW.ROLLEASEACMEDA.COM/US/PRODUCTS/MOTORIZATION](https://www.rolleaseacmeda.com/us/products/motorization)
2. CLICK/DOWNLOAD: 'TORQUE CALCULATOR'

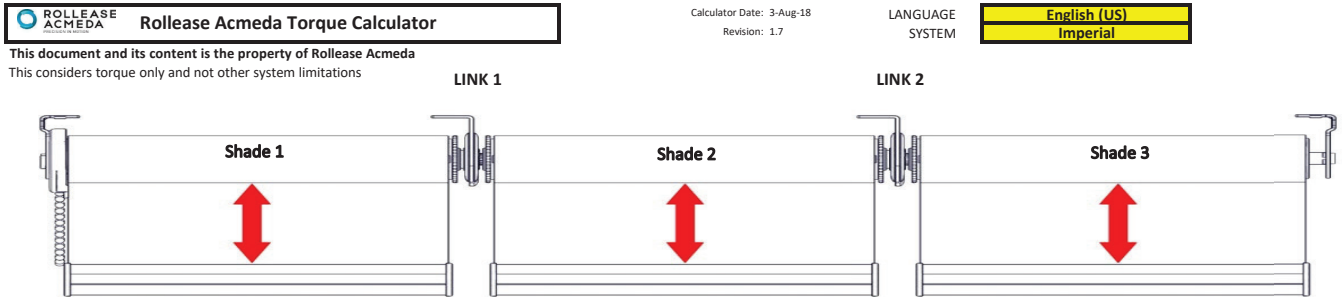

Shade 1			Shade 2			Shade 3		
WIDTH	60.0	inch	WIDTH	60.0	inch	WIDTH	0.0	inch
SHADE WEIGHT	5	lb	SHADE WEIGHT	5	lb	SHADE WEIGHT	0	lb
ROLL SIZE	2.2	inch	ROLL SIZE	2.2	inch	ROLL SIZE	0.0	inch
SHADE TORQUE	4	lbf-in	SHADE TORQUE	4	lbf-in	SHADE TORQUE	0	lbf-in
			LINK 1 TORQUE	4	lbf-in	LINK 2 TORQUE	0	lbf-in

SELECT CONFIGURATIONS			INPUT FOLLOWING CUSTOM PARTS, IF REQUIRED		
DROP	80.0	inch	FABRIC		
FABRIC	Phifer, SheerWeave Style 7100		WEIGHT	450.0	oz/yd ²
WEIGHT	19.8	oz/yd ²	THICKNESS	0.50	inch
THICKNESS	0.02	inch	HEM BAR	0.38	lb/yd
HEM BAR	HB16		BALLAST	0.20	lb/yd
BALLAST	NONE				
PRE-WRAP	No				
Tube	1.5" (38mm) Tube				

SYSTEM SUMMARY					
CONTROL TORQUE REQUIREMENT	1.0	Nm	9	lbf-in	
TOTAL SHADE WEIGHT	11	lb			
LINK TORQUE REQUIREMENT	0.5	Nm	4	lbf-in	

COMPATIBLE CLUTCH
 SL15
 SL20
 SL30
 RGALH
 R16
 R24

COMPATIBLE MOTOR
 MTDCRF25-1.1
 MTDCBRF25-1.1
 MTDCRFQ28-2
 MTDCBRFQ28-2

COMPATIBLE LINK SYSTEM
 EASY-LINK SKYLINE
 EASY-LINK
 EASY-LINK UNI-JOINT
 INFINITE LINK SYSTEM

12. KNOWN RETROFIT-ABLE SHADE CHART

	Shade Type		Min Size - Width Tube	Max Size - Width	Max Height	Motor Size	Min Tube	Notes
Custom Brands Group	Roller		21"-60"			1.1	1.25	
Custom Brands Group	Roller		27"	120	120	2.0	1.5-2.0	
Custom Brands Group	Roller		36"	120	120	3.0	2.0	
Custom Brands Group	Roller		36"	144	144	Q3.0	2.0	
Custom Brands Group	Roller		36"	168	168	Q10	2.0	
Custom Brands Group	Cordless Cellular	End Mount	24"	See Chart		CL 0.6	N/A	6" In
Custom Brands Group	Cordless Cellular	Center Mount	24"	See Chart		CL 0.8	N/A	8" Between Ladders
Custom Brands Group	Horizontal	Tilt Only	18"	102"	96"	VT 1.0 Tilt	N/A	6" In
Custom Brands Group	Window Shading		24"	120"	102"	1.1-2.0	1.5	
Custom Brands Group	Dual Shade		24"	96	96	1.1	1.5	
Custom Brands Group	Dual Shade		28"	120	120	2.0	1.5	

Springs Window Fashions	Roller - Clutch		24"	96	96	1.1	1.25	
Springs Window Fashions	Roller - Smart Pull		28"	120	120	2.0	1.5	
Springs Window Fashions	Roller - Clutch		36"	144	144	3.0	2.0	
Springs Window Fashions	Roller - Clutch		36"	168	168	Q10	2.0	
Springs Window Fashions	Cordless Cellular	End Mount	15"	See Chart		CL 0.6	N/A	6" in required
Springs Window Fashions	Cordless Cellular	Center Mount		See Chart		CL 0.8	N/A	8" Between Ladders
Springs Window Fashions	Horizontal		18"	102"	96"	VT 1.0 Tilt	N/A	6" in required
Springs Window Fashions	Roman - CCL/Cordless	End Mount	18" Min Headrail	18"	86"	CL0.6	N/A	6" required
Springs Window Fashions	Roman - Cordless/CCL	Center Mount	24" Min Headrail	18"	86" - 96"	CL0.8	N/A	8" Between Ladders

Lafayette Interior Fashions	Roller - Clutch		24"	96	96	1.1		
Lafayette Interior Fashions	Roller		28"	120	120	2		
Lafayette Interior Fashions	Roller		36"	144	144	3.0		
Lafayette Interior Fashions	Roller		36"	144	144	Q3		
Lafayette Interior Fashions	Roller		36"	168	168	Q10		
Lafayette Interior Fashions	Cordless Cellular	End Mount	24"	See Chart		CL0.6	N/A	6"
Lafayette Interior Fashions	Cordless Cellular	Center Mount	24"	See Chart		CL0.8	N/A	8" Between Ladders
Lafayette Interior Fashions	Horizontal	Tilt Only	18"	102"	96"	VT 1.0 Tilt	N/A	6" in
Lafayette Interior Fashions	Tenera		24"	120"	102"	1.1 - 2.0	1.5	
Lafayette Interior Fashions	Illusions		24"	96"	96	1.1	1.5	
Lafayette Interior Fashions	Illusions		28"	120	120	2.0	1.5	
Lafayette Interior Fashions	Roman Shade		24"	96	96	1.1		Must be Quick Lift Clutch
Lafayette Interior Fashions	Roman Shade		28"	120	120	2.0		Must be Quick Lift Clutch

Phase II	Roller Shade	Premium CCO Only	24"	96	96	1.1	1.25	Must be Alum Tube 1.25">
Phase II	Roller Shade	Premium CCO Only	28"	120	120	2.0	1.5	Must be Alum Tube 1.5">
Phase II	Roller Shade	Premium CCO Only	36"	144	144	3.0	2.0	Must be Alum Tube 2.0">
Phase II	Roller Shade	CCL/Chain Operation	24"	96	96	1.1	1.25	Must be Alum Tube 1.25">
Phase II	Roller Shade	CCL/Chain Operation	28"	115	120	2.0	1.5	Must be Alum Tube 2.0">

Timber Blind Metro Shade	Roller Shade	Beaded Chain	24"	96	96	1.1	1.25	
Timber Blind Metro Shade	Roller Shade	Beaded Chain	28"	120	96	2.0	1.5	
Timber Blind Metro Shade	Roller Shade	Beaded Chain	36"	144	192	3.0	2.0	

25mm 1.1 Nm Li-on Motor, Skyline 1.25 or 1.5 Tube

28mm 2.0 Nm li-on Motor 1.5 or Larger Tube

Tools needed:

1. #2 Phillips head screwdriver
2. Wide blade flat head screwdriver



Preparing for the retrofit:

1. Removing the clutch system:
 - Locate the clutch side



- With a wide blade flat head screw driver separate the clutch from the tube by twisting the screwdriver forcing the clutch out of the tube.

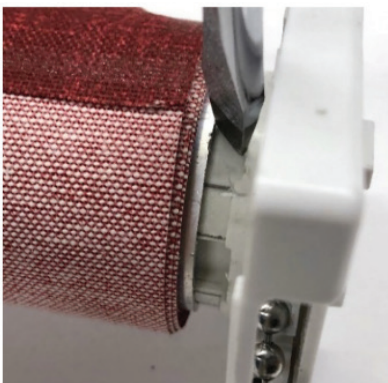

SECTION E | ROMANS

Prepare the Motor

- Ensure you have the correct Crown & Drive for the motor. 1.25 or 1.5"
- The parts package will indicate 25mm or 28mm 1.25 or 1.5" based on the motor choice.



- Attach the Crown by slipping it over the motor and to the motor head collar.
- On the 25mm make sure the tab lines up with the slot.

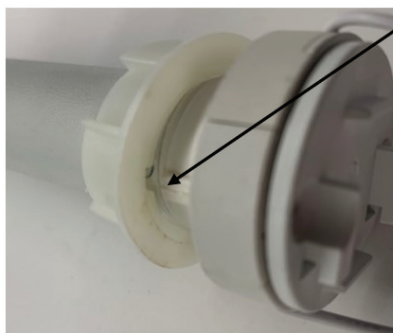

- Attach the drive on the output pin of the motor and secure the retainer clip into the groove in the output pin.



SECTION E | ROMANS

- Attach the bracket adapter to the motor using the phillips screws provided. Be careful not to overtighten the screws. Attach so the tabs are facing down to fit into the bracket so the antenna is facing up allowing access to the p1 button from the bottom of the motor head.

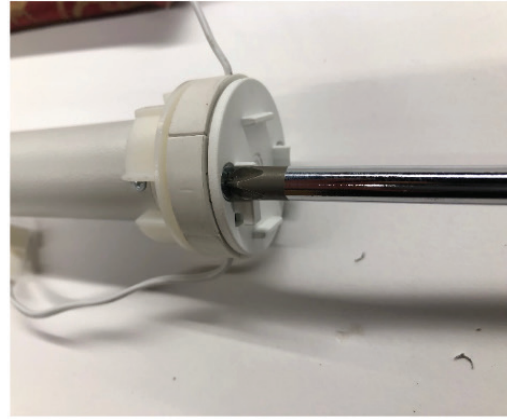
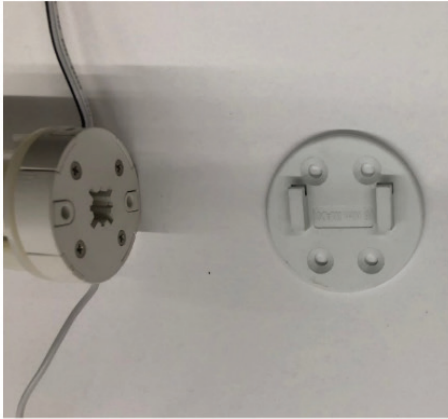

- Slide the motor drive into the tube ensuring you are using the smaller slot so there is as little play between the tab and slot as possible. Using the larger tab will affect the operation of the shade.

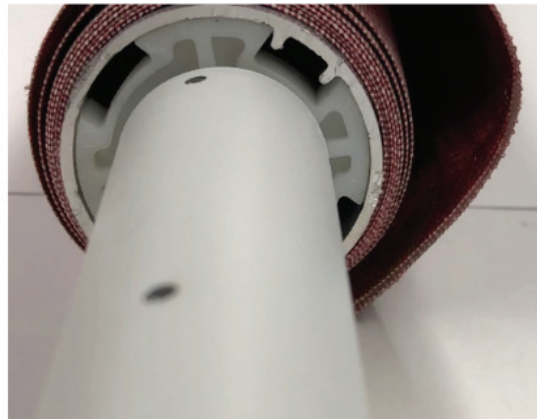

- Slide the motor into the tube until you reach the motor crown and collar. Again, ensure you are using the proper tab so there is as little play as possible.



- Install the shade assembly into the brackets.
- Pair and program motor

25mm 1.1 Li-On, R-Series 1.25" or 1.5" Tube

Lafayette Illusions

Tools needed:

1. #2 Phillips head screwdriver
2. Wide blade flat head screwdriver



Preparing for the retrofit:

- Pry the end cap off the shade cassette to expose the clutch and bracket.

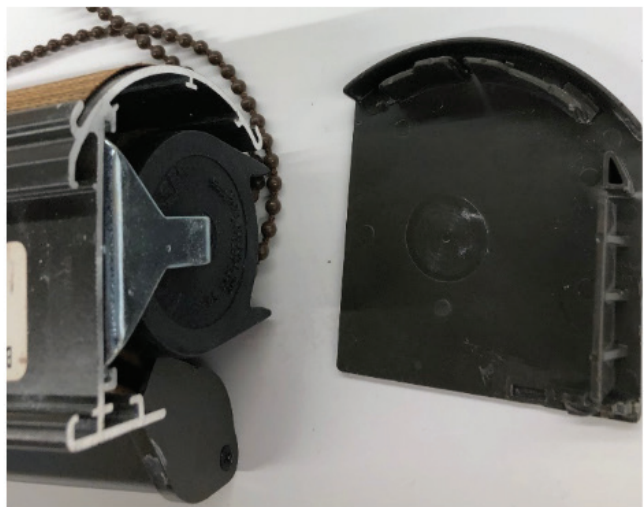

- Carefully Pry the bracket out of the cassette head rail
- Remove the clutch assembly from the tube.

Prepare the Motor

- Ensure you have the correct components for the tube.

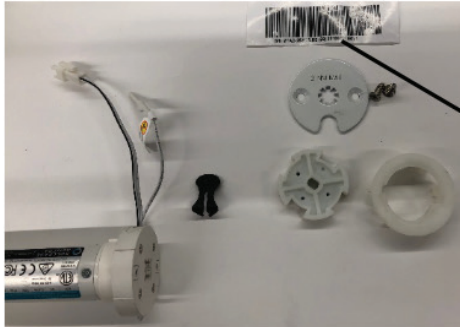

- Add the adaptor plate to the motor head with the screws provided



- Attach the drive on the output pin of the motor and secure with the retainer clip into the groove in the output pin.



SECTION E | ROMANS

- Slide the motor drive into the tube ensuring you are using the smaller slot so there is as little play between the tab and slot as possible. Using the larger tab will affect the operation of the shade.



- Attach the roller shade bracket back into the cassette head rail. This is a friction fit so it should slide in and tap in with the back of the screwdriver or a mallet.
- Make sure the bracket is seated properly.



- Place the end cap back into the cassette.

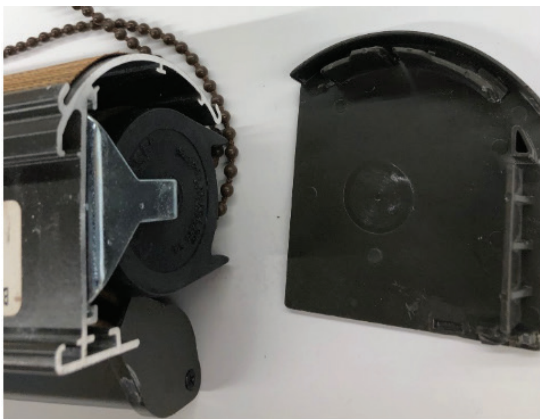

- Reinstall the shade and pair and program the motor.

SECTION E | ROMANS

25mm 1.1 Nm Li-on Motor, Skyline 1.25 or 1.5 Tube

28mm 2.0 Nm Li-on Motor 1.5 or Larger Tube

Transitional shades

Tools needed:

1. 4-way screw driver, Drill Motor
2. # 10 counter sink bit, Exacto Knife.

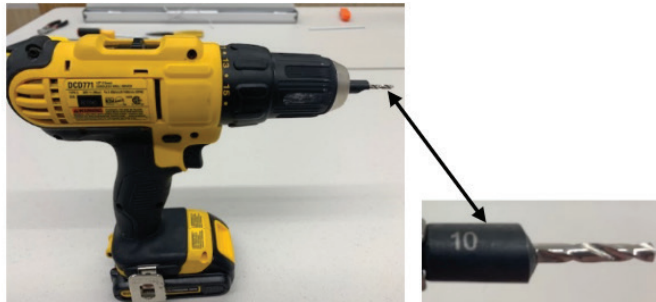

Preparing for the retrofit:

1. Removing the clutch system:
 - Locate the clutch side and remove the decorative end cap. It snaps onto the clear plastic end cap.
 - Remove the screw holding the clear plastic end-cap and clutch in place.
 - Remove the clutch system from the tube.

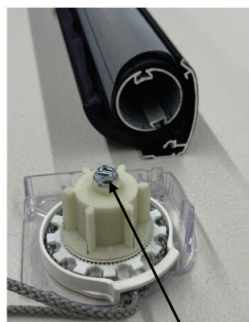
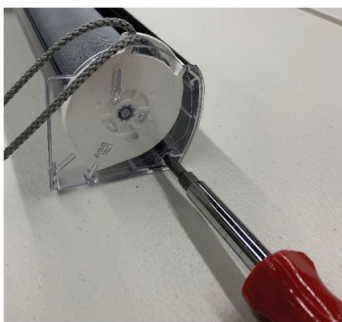

Separate the clutch system from the clear plastic end cap by removing the 5/16 retainer screw from the clutch. You can use the large end of the 4-way screw driver as a nut driver to remove the retainer screw.



Preparing the Motor:

Using the motor to bracket adaptor as a template, align the adaptor so the groove is oriented in the down position away from the top of the end cap. Mark the hole location with a sharpie.

Drill the marked holes with the #10 counter sink bit. If you don't have a countersink bit use a 1/8" Bit.

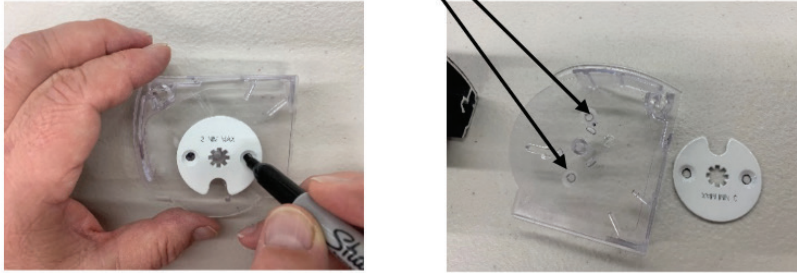

Installing the drive will take some trimming as the tube profile is slightly larger than the grooves in the actual drive. The lines on the drive are what you will want to trim. It represents about 1/32 on each side for both grooves.

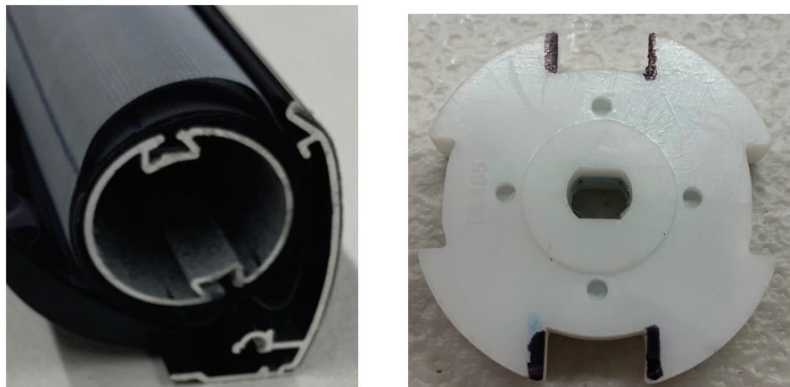

I put the drive in a vice to keep it steady while trimming.



SECTION E | ROMANS

The Crown will also need to be trimmed. Notice the ridge next to the groove the tabs will fit into. Part of the crown will need to be trimmed off on both sides to fit into the tube. Lay the crown flat on a solid surface and trim the line as shown in the picture below.

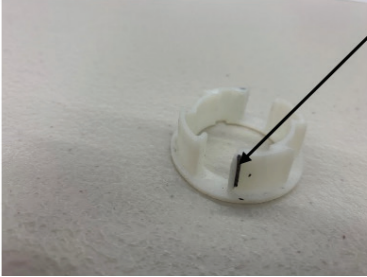

- Slide the crown over the motor tube to the motor head ensuring the reference tabs are aligned properly.

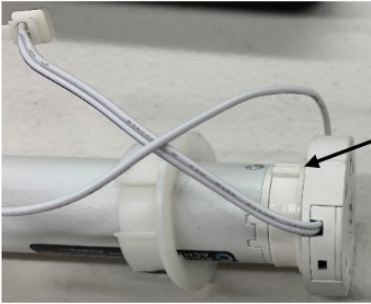

- Attach the previously drilled plastic end cap to the motor head with the screws provided in the adaptor kit.

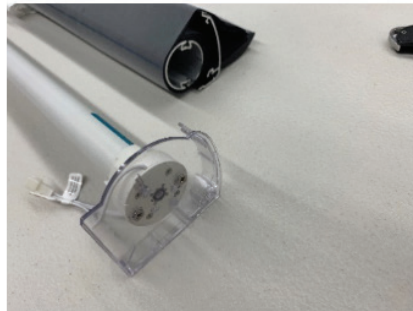
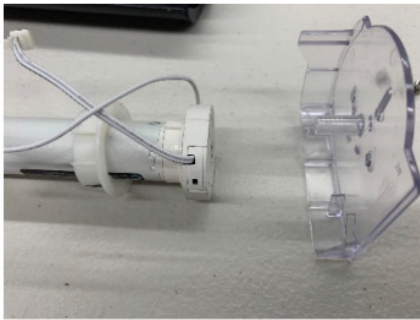

- Slide the drive and motor into the tube. Make sure you are putting the trimmed portion of the drive groove over the tab and slide the motor to the crown.
- Slide the crown into the tube taking note ensuring the trimmed crown is aligned properly.
- Insert the plastic end cap back into the cassette grooves and replace the set screw previously removed in the disassembly portion of the instructions.



SECTION E | ROMANS

- Snap the decorative end cap back in place over the clear plastic end cap.

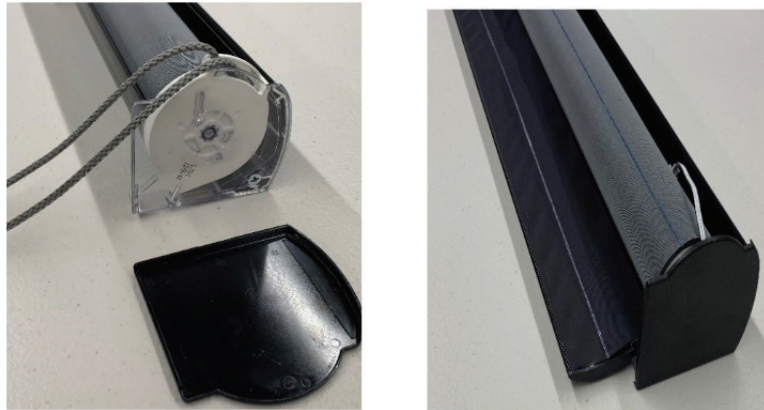

- Place the retrofitted blind back into the brackets and pair and program motor.

SECTION E | ROMANS

CL 0.8 Cord Lift motor
REMZMR-Cellular= adapter kit
MTBPCKR-LFT-TLT=rechargeable battery pack

Tools needed:

1. Hacksaw
2. Needle nose pliers
3. Flat head screwdriver



Preparing for the Retrofit:



Remove the end caps from the shade

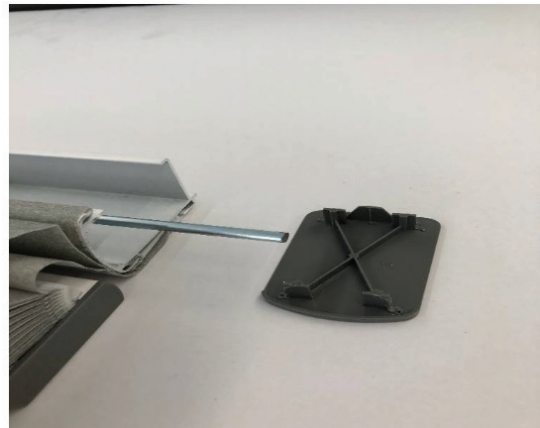

Remove the pinion shaft from the shade

SECTION E | ROMANS

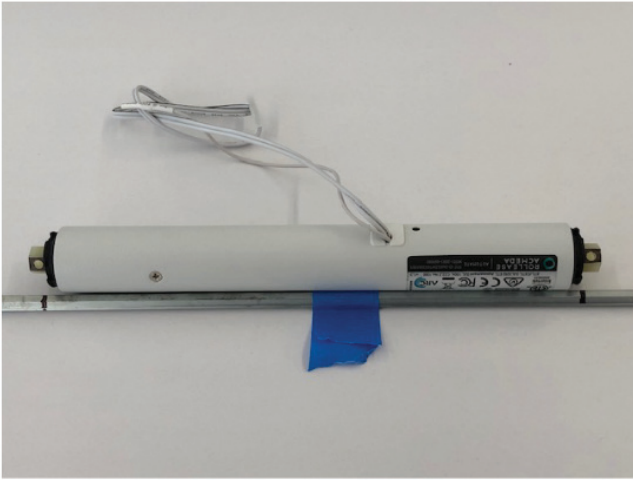

- Align the motor on the pinion shaft. You can mark the shaft or use blue tape to reference where to cut the shaft



- Cut pinion shaft with hacksaw



- Test fit adapters onto shaft and headrail

SECTION E | ROMANS

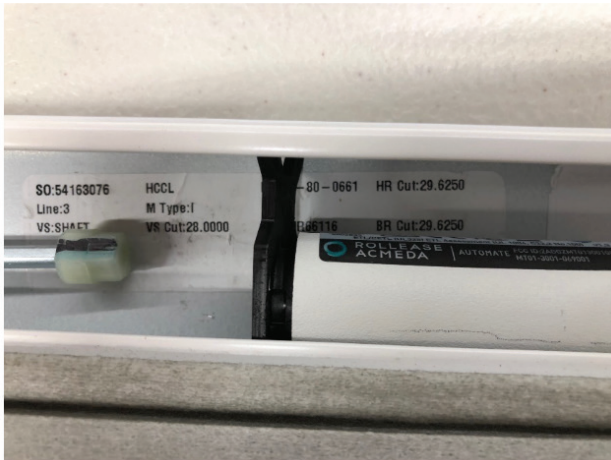

- Insert motor into headrail adapters



- Turn shaft until cords are tight. Make a line on the adapter for reference when inserting into motor this will help with shade alignment



- Re install end caps

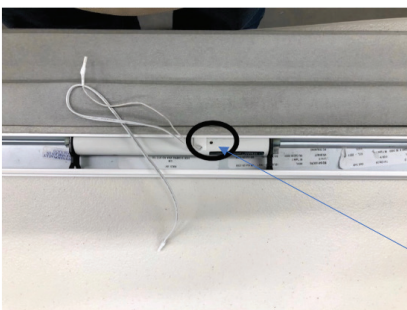

- Connect battery and pair with remote before installation see P1 button above

Traversing Rod Headrail Lift System Retrofit Guide – CL 0.6 End Mount Motor

Tools needed:

(not shown – tape measure, Dremel tool with cutoff wheel)



SECTION E | ROMANS

PREPARING FOR THE RETROFIT: (Measure twice...cut once)

Roll shade all the way up. Pop cover off lift system. Roll shade all the way up. Pop cover off lift system.



The motor assembly needs at least 5.5" in the headrail. Measure from the end of the headrail to the center shaft to ensure the available space. Make sure that the shade is completely rolled up and shaft is fully traversed to the drive side. Consider that the cord clip can be moved inboard on the shaft – in our case, the clip could move left almost an inch before impacting the cord roll up. When possible add .5" to 1" to this measurement to enable some space between the drive shaft and the guide shaft opening.



Move the cord clip over and mark your cut line with tape.

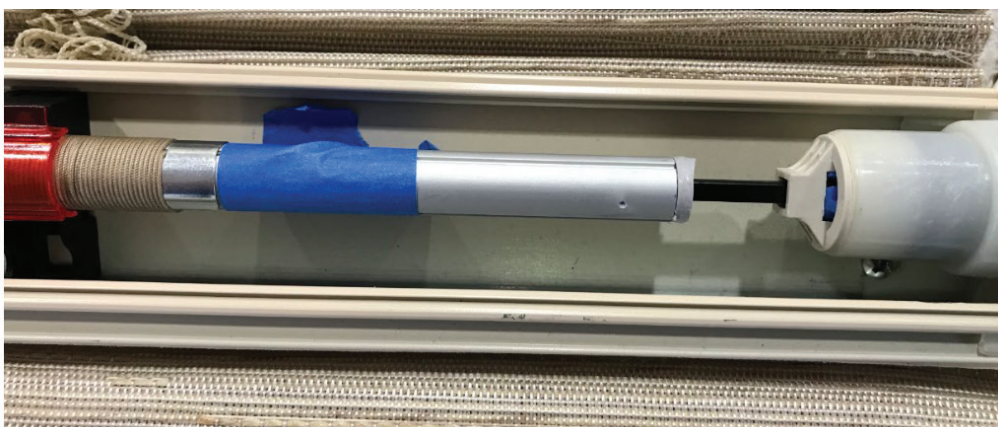

DISASSEMBLING AND PREPARING THE MANUAL SHADE:

Begin disassembly by removing the mechanical lift system set screw.

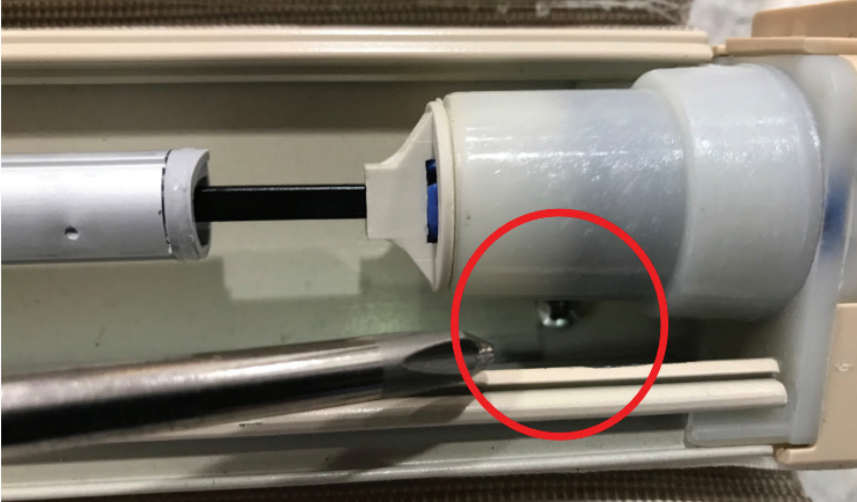

Slide lift mechanism out of the headrail.



SECTION E | ROMANS

Move to idle side. With a screwdriver, gently pry out idle guide mount.

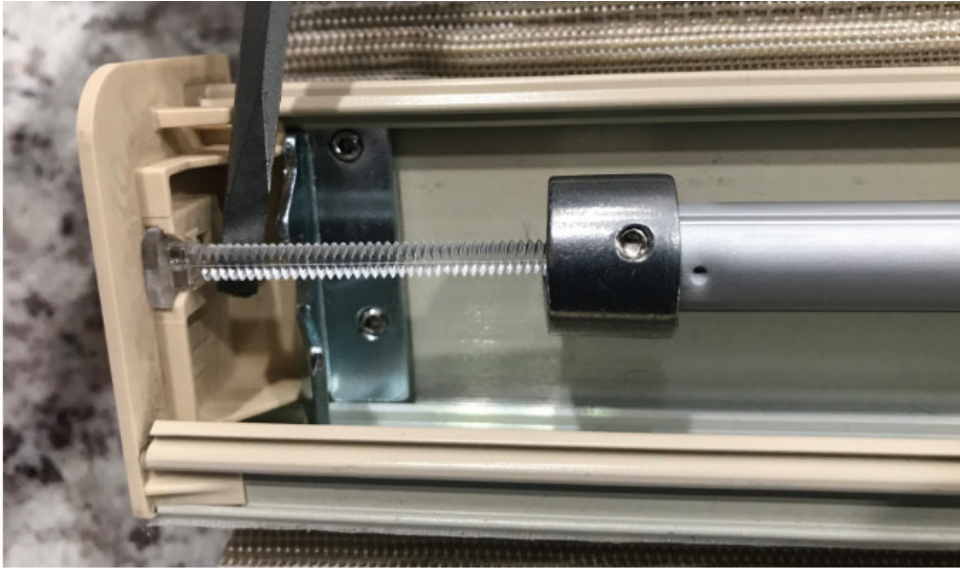

Remove entire lift assembly from headrail. NOTE: red transparent mounts must be removed prior to lifting out shaft. Carefully unroll the lift cord and remove the cord clips. The lift shaft should now be completely free of the shade assembly. With some tape, mark your clip locations.



With a 5/64" Allen wrench, remove the set screw holding on the idle end retainer.



SECTION E | ROMANS

Disassemble the idle end by rotating the idle shaft (clear plastic piece) clockwise and sliding the retainer (silver piece) off the shaft.



We will cut down the idle end of the shaft in order to retain the integrity of the drive shaft guide.

Transfer the "cut" measurement we took earlier on the drive side to the idle side of the shaft. In our example, this was 3 3/8".



Transfer that measurement to the idle side. Mark cut line with tape.



SECTION E | ROMANS

We are going to make two cuts here. First will be on the indentations in the shaft (around $\frac{3}{4}$ " on the above image); second will be at our cut line marked by tape. Use a Dremel tool or angle grinder with cutoff wheel to make the cuts to the shaft. NOTE: Use eye protection.



Remove the white plastic idle guide from the end of the shaft. Sometimes this will simply slide out, other times it is pressed in there tightly. In the latter case, attach a pair of vice grips on the outer shaft and use a drift (or something tapered) to press against the inside of the guide. With a little tap on the vice grips, the guide will pop out.



Now we have a completely disassembled idle side, ready for reassembly. You will not use any of the pieces circled in red.



NOTE: The shaft has an inner star profile which mates to the plastic guide establishing lateral integrity.



Reassemble the idle side by sliding the plastic guide into the end of the shaft. This may require a gentle tap with a rubber mallet to get the guide to set fully in place.



Next, slide the guide retainer onto the shaft. Make note that there is an alignment groove on the guide and retainer. Align these.



Tighten the set screw on retainer with your 5/64" Allen wrench. With the shaft retainer firmly secured, the guide will remain in place. Insert the idle shaft (clear plastic piece) into the guide and rotate it counterclockwise until about a half inch of shaft remains exposed.

REASSEMBLING THE SHADE WITH MOTORIZATION:

Begin reassembly of the lift system. Start by attaching the cord and clips in the same general location as they were before (marked by tape).



Let the shade extend fully to its maximum open position. While the shaft assembly is completely free, take up any excessive slack in the cords by rotating the shaft towards the back of the shade. Place the shaft in the cradles and adjust the cord clips if necessary. Remove the tape. Once there is a minimal amount of tension on the cords while the shaft is placed in its cradle, adjust the idle shaft so it is about 1/4" from its mechanical stop.

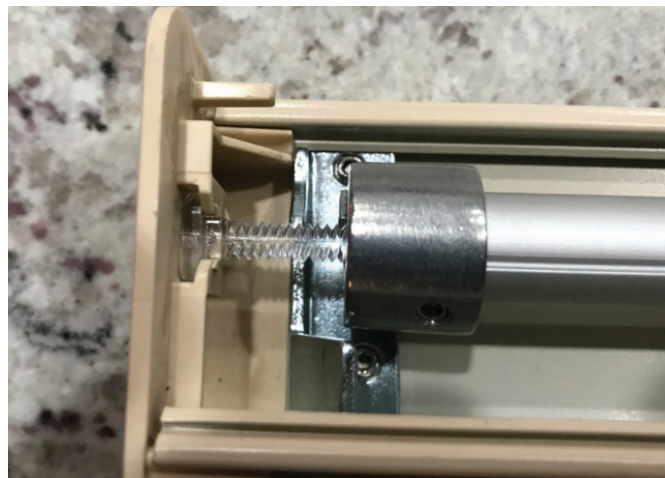

Now roll up the entire assembly by manually turning the shaft. Make sure the cords do not overlap or bird nest – adjust cord clips as necessary. Motor ready assembly should look like the below.

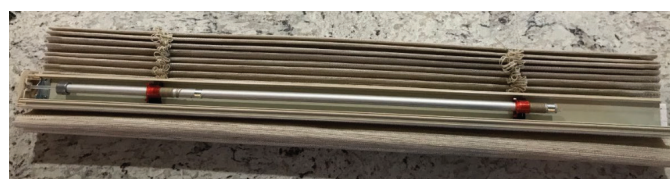

Remove the drive shaft from the manual lifting assembly. This requires breaking the assembly with a screwdriver or cutting the shaft with your Dremel tool.



Time to prepare your motor assembly. This will consist of two cradles, the single output shaft motor, and a shaft adapter.



Make sure your motor cradles are oriented correctly for alignment with the drive shaft.

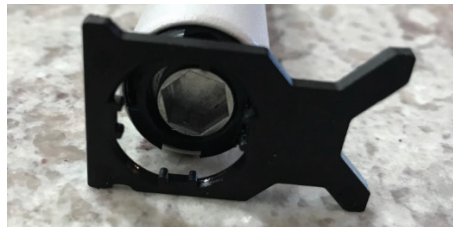

Slide the motor assembly into the headrail. The shaft adapter is a press fit both on the motor side and where it attaches to the drive shaft. The press fit should be sufficient to hold the drive shaft in place. (If you are concerned that the drive shaft might slide off the adapter while traversing, add a little JB weld where the two pieces interface – circled in red below)



Now continue to disassemble the manual lift mechanism. We will reuse the two components circled in red.

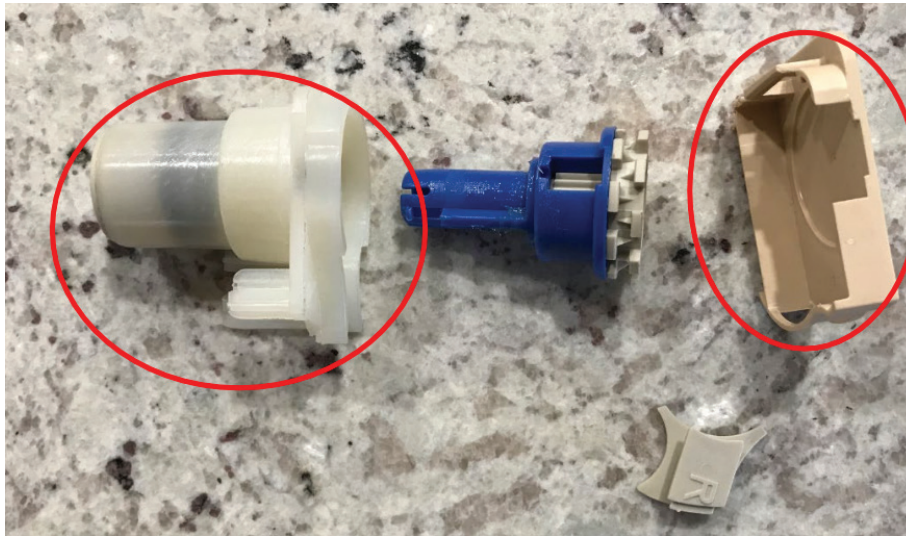

Carefully trim the spring assembly until it looks like the below. This part does not serve any function other than holding on the end cap. There is no easy way to this – use your Dremel tool and a knife to trim it until it fits flush to the headrail and around the motor assembly.



Once the clear plastic piece is trimmed to fit, you can either leave it as is or JB weld it to the black motor cradle for a more secure fit.



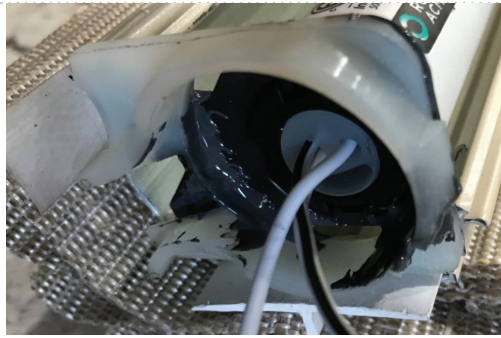

Once glue has dried, reinstall end cap cover (you can route wires through cover) and configure shade limits. Adjust cords and clips as necessary.



Automate VT Tilt Motor Retrofit – Horizontal Blind

Tools needed:

1. Flathead Screwdriver
2. Scissors
3. Sharpie
4. Double Sided Tape
5. Tape Measure
6. Hacksaw (metal cutting tool)
7. File
8. Safety Glasses



Preparing for the retrofit:

Remove the blind from the brackets

Locate the 'Tilt Control' side

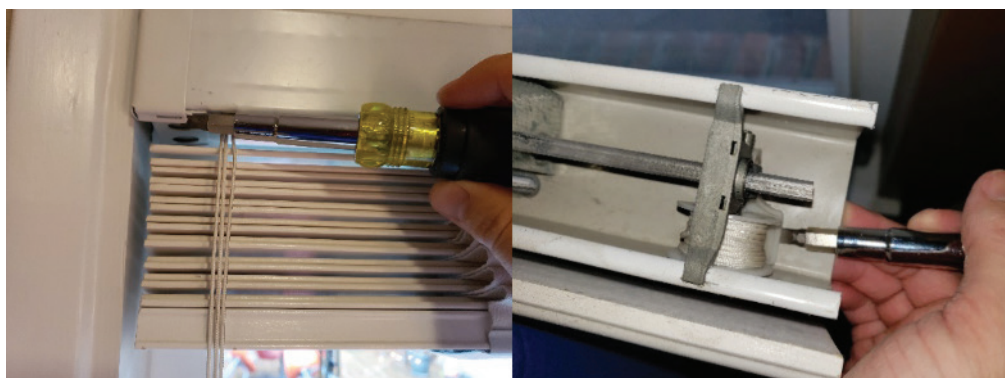

- With a flathead screwdriver, remove the tilt control from its holder

Assess the headrail:

- The tilt motor needs 4in on the 'Tilt Control' side from end of shade
- 1.5" headrail will need included low profile cradle
- 2" headrail will need high profile cradle: MTAD-TILT-HPCRADLE
- 'Square' Shaft will not need a shaft adapter
- 'Hex' Shaft will need a shaft adapter: MTAD-TILT-SA-5HEX

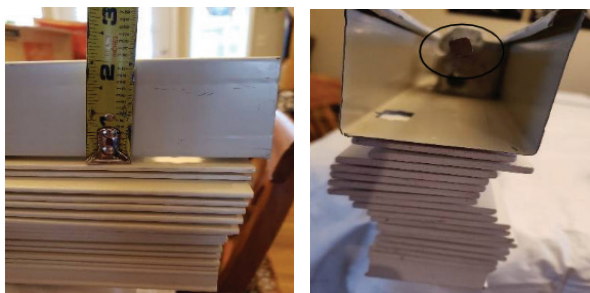



- Cut the 'Tilt Control' cords so the string can fit through the hole.
- Remove the manual 'Tilt Control'

Assess the headrail:

- Measure, mark, and cut to 3.25in (.75in of the shaft will be inserted into the motor)
- File rough edges

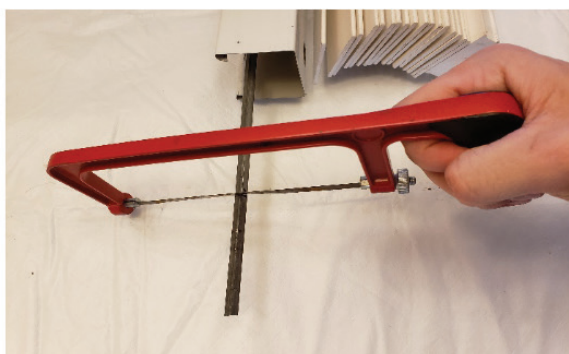
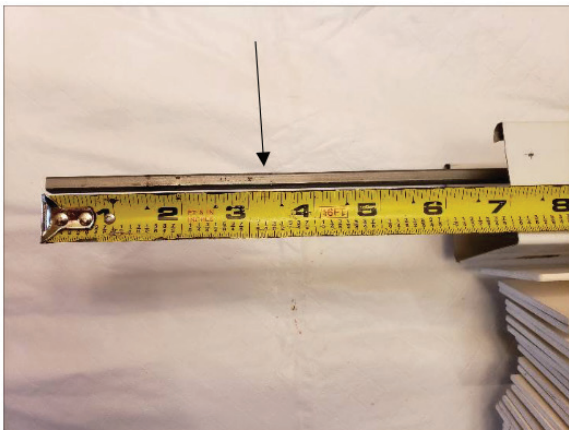

Prepare the Motor

1. Ensure you have the correct parts, cradle, and shaft adapter if necessary
 - Motor: MTDCRF-TILT-1
 - Battery(650mah): MTBPCKR-LFT-TLT
 - In this instance, we need a High-Profile Cradle: MTAD-TILT-HPCRADLE
 - We do not need a shaft adapter (MTAD-TILT-SA-5HEX)

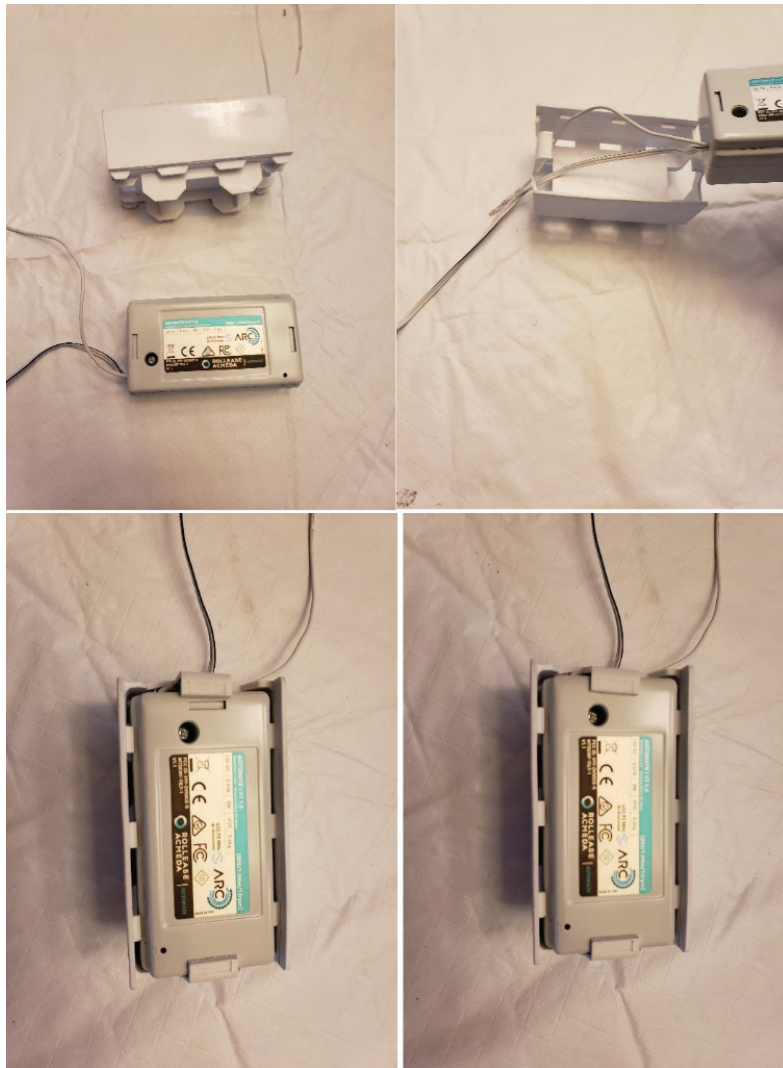

1. Run the antennae and power connector through the available port
2. Settle motor into cradle
3. Secure down the 'Clips'
4. The motor is ready for install!

Installing the Motor and Battery

All DC motors have external battery packs



4. Install battery inside headrail, securing with double sided tape
5. Line up the motor/cradle and slide into headrail
6. Insert the shaft all the way into the motor
7. Ensure motor is far enough in

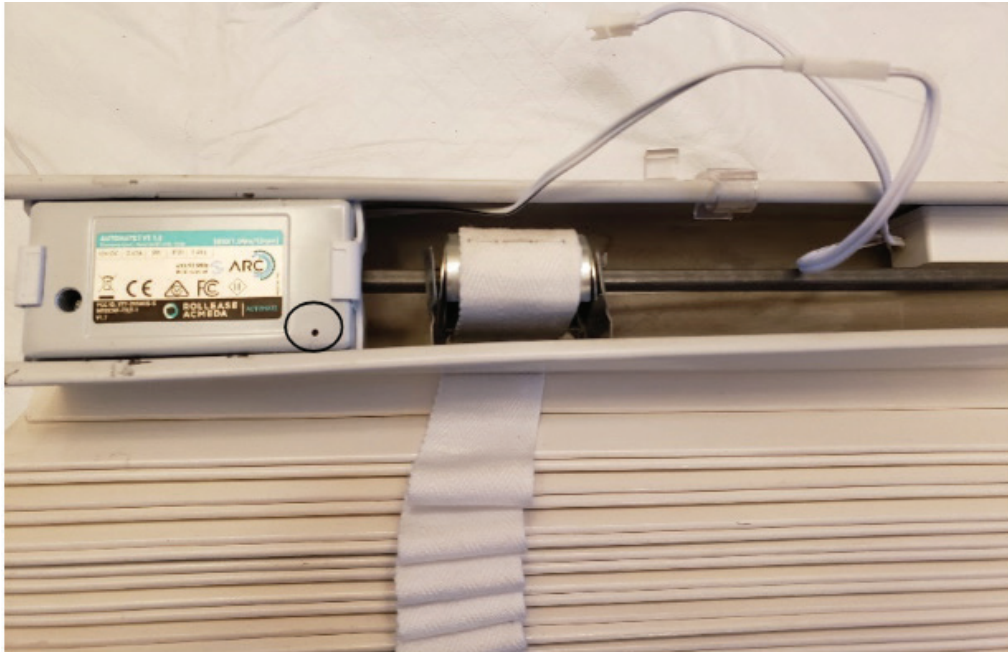

8. Slide power cable underneath cradle and attach to battery
9. **Pair the motor to the remote before hanging the shade:**
 - P1 button is circled above



10. Slide antennae through old tilt control hole
 - Alternatively, allow antennae to stick out top of headrail
 - Install shade
11. Leave charging cable out
 - Hides well behind fascia

SECTION E | ROMANS

Automate VT Tilt Motor Retrofit – Horizontal Blind

Tools needed:



Preparing for the Retrofit:

- 1.) Remove both End Caps 1 Screw)
 - a. Rod will be attached to the control mechanism, remove this screw



SECTION E | ROMANS

2.) Remove the rod from the control mechanism using the allen key.

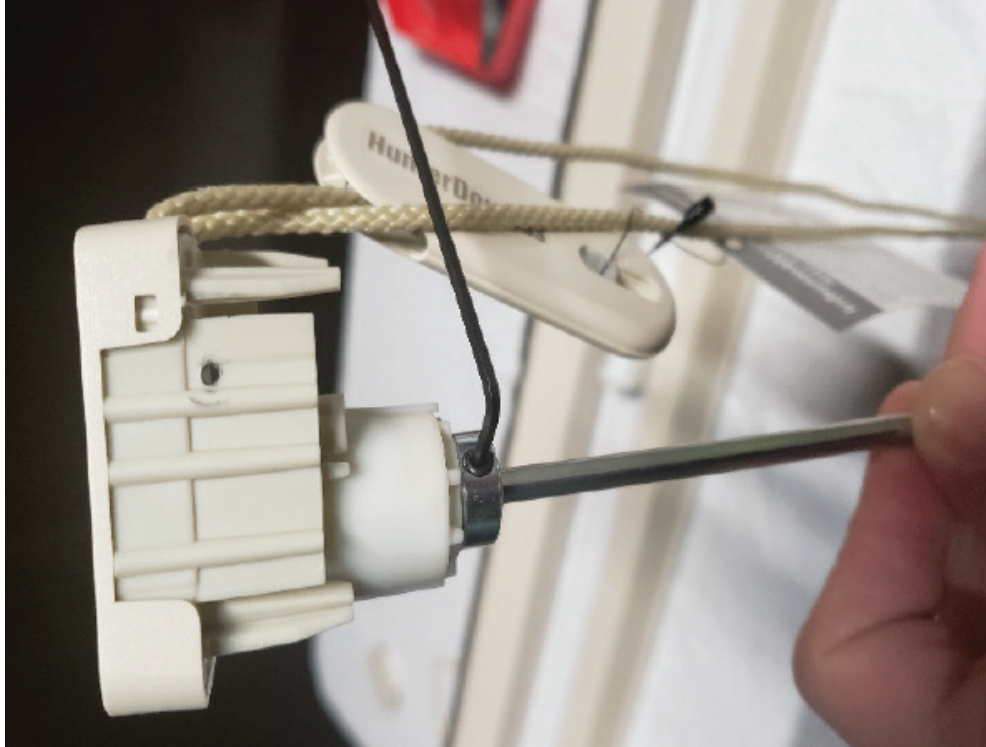

3.) Remove the headrail, this will expose the rod and spools

a. Remove the rod and the black limiter in the headrail



SECTION E | ROMANS

Preparing the Motor

- 1.) Utilizing the Springs motor cradle, remove the bottom feet with a utility knife from 2 motor cradles
 - a. You will utilize the 'V Groove' shaft adapter. Install all components on motor (Not pictured)

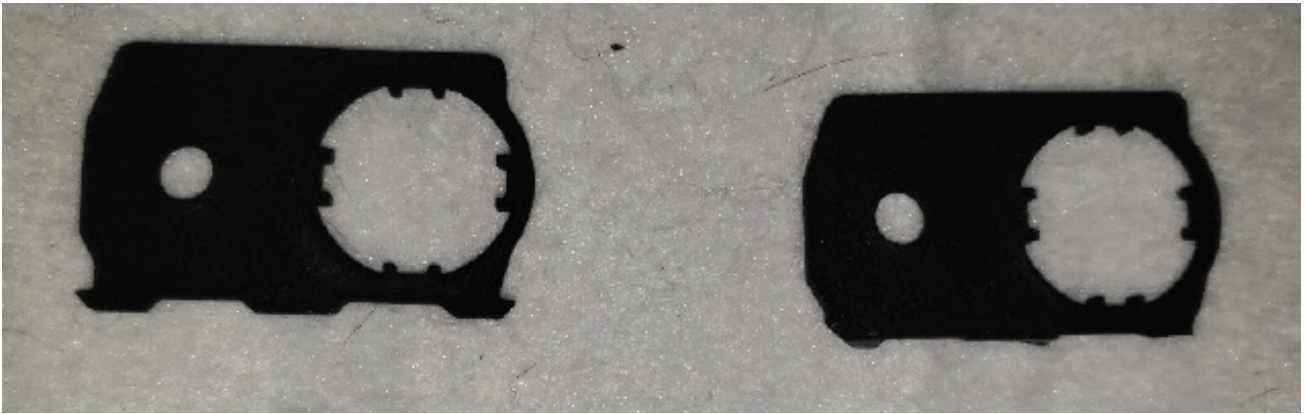

Perform the Retrofit:

- 1.) Ensuring the motor aligns with the orientation of the spools/rod slide the motor into the headrail



2.) Slide the headrail back onto the shade



2.) Slide the headrail back onto the shade



HD Pirouette Retrofit

25mm 1.1nm Motor with 1.5" Crown and Drive Kit for 1.5" Tube

Tools and Parts Needed:



Preparing for the Retrofit:

1.) Remove End cap and cover on the control side (2 Screws)

a. The control mechanism will be attached to the end cap as you remove it

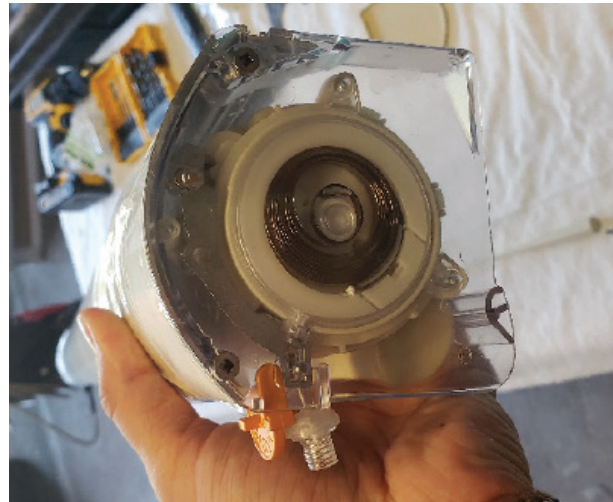

2.) Remove control mechanism from End cap

a. Remove 3 screws

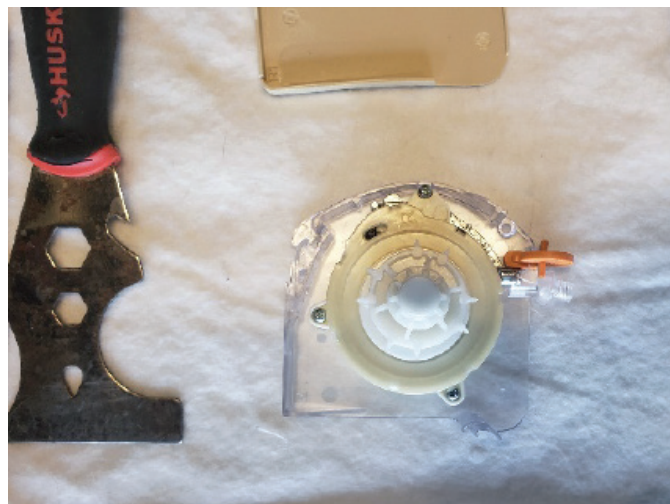

SECTION E | ROMANS

b. Remove Coil and Cut/Remove String



c. Cut the extra tab off the end cap

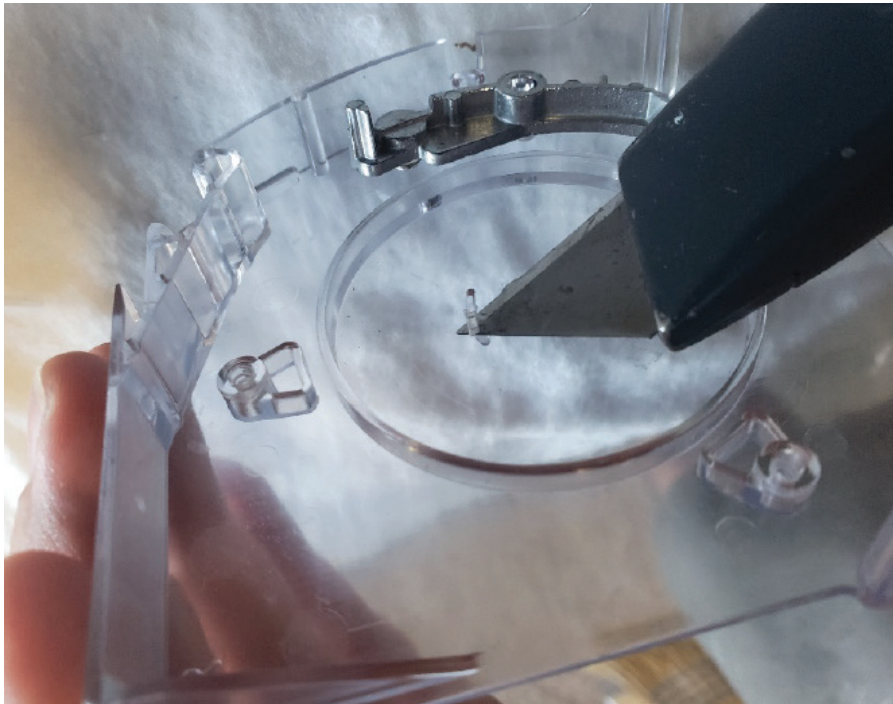

SECTION E | ROMANS

Preparing the Motor

1.) Preparing the C&D Kit

- a. Line up the drive and mark where to cut
 - i. *NOTICE ORIENTATION OF DRIVE*



- b. Cut down Crown and Drive ensuring a snug fit in the tube

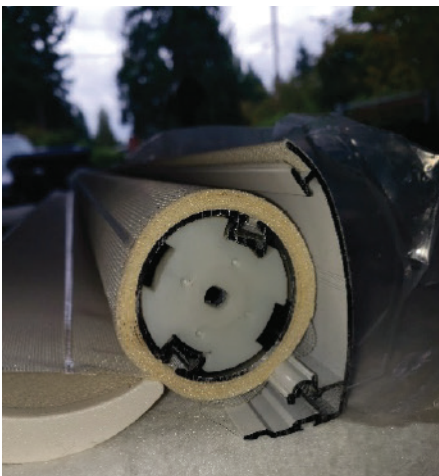
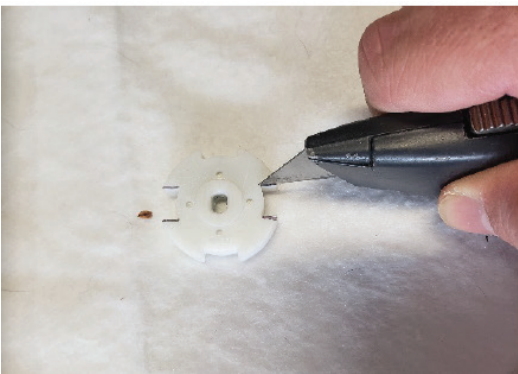

SECTION E | ROMANS

1.) Install the Crown and Drive kit and Bracket Adapter/End Cap

a. Remove Skyline adapter and Install R16 Bracket adapter onto motor(do not put screws in)



2.) Line up motor on end cap, ensuring the p1 button and charging port are facing down!

Mark where 3 holes line up with sharpie

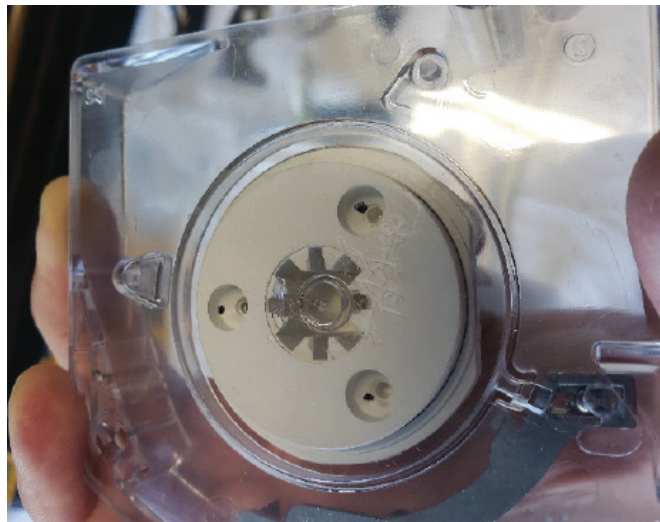

3.) Utilizing a counter sink bit, drill 3 holes

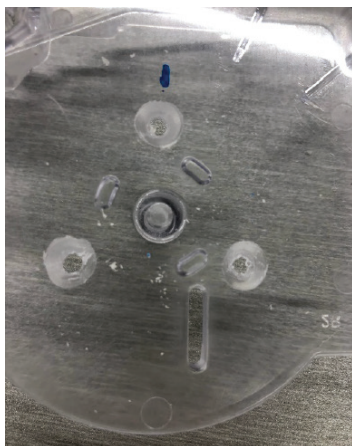

4.) Use the 3 SCREWS, secure end cap to motor head



Perform the Retrofit:

- 1.) Ensuring the end cap is lined up accordingly, install the motor into the tube
 - a. Pro tip – since the motor is attached to the end cap/bracket and The DRIVE needs to align properly, pair the motor and utilize the micro adjustments to line the drive up without having to rotate the end cap

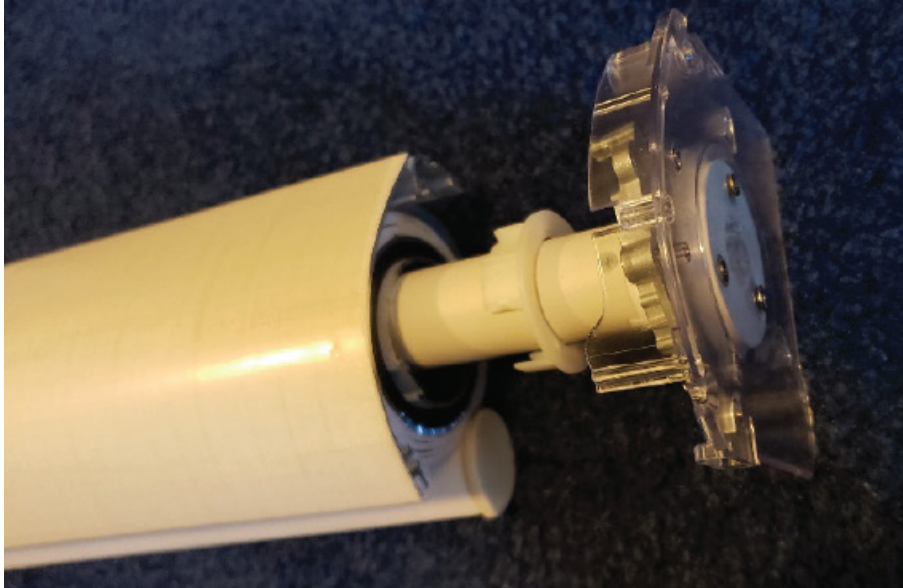

- 2.) Re-install the screws that hold the end cap to the shade



SECTION E | ROMANS

3.) Removing the idler mechanism

- a. On the Idler end, remove the end cap cover/screw



- b. Remove the tension device (1 screw) and limiter

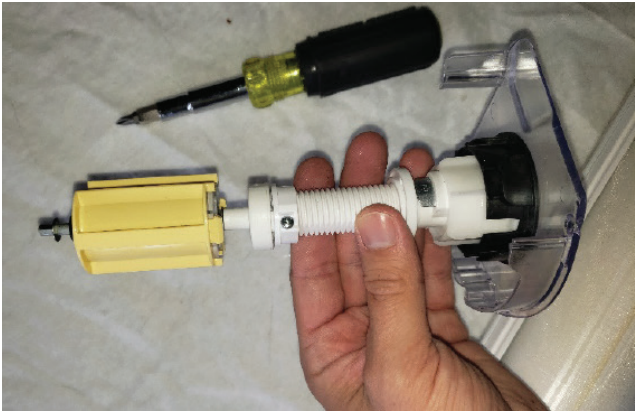

- c. Install the end cap back into the shade and insert screws



SECTION E | ROMANS

Hunter Douglas Silhouette 50"x50"

25mm 1.1nm Motor with 1.5" Crown and Drive Kit for 1.5" Tube

Tools and Parts Needed:



Preparing for the Retrofit:

1.) Remove End cap on control side (1 screw)

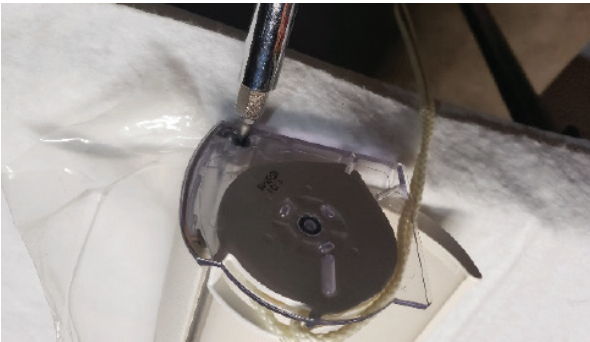

2.) Remove center screw from clutch mechanism



2a) Remove clutch from end cap

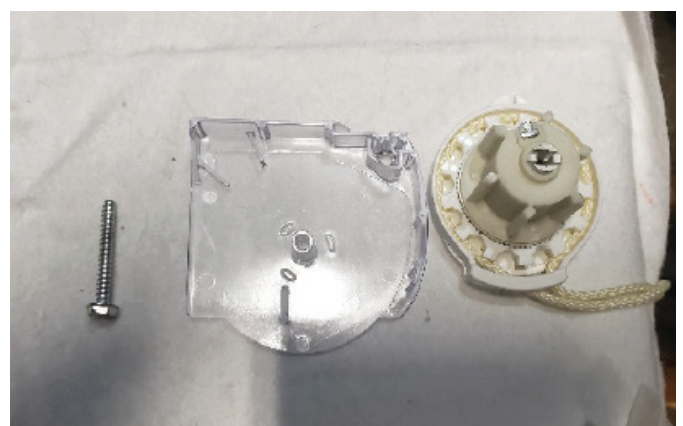

SECTION E | ROMANS

Preparing the Motor

1.) Preparing the C&D Kit

- a. Line up the drive and mark where to cut
 - i. *NOTICE ORIENTATION OF DRIVE*



- b. Cut down Crown and Drive ensuring a snug fit in the tube

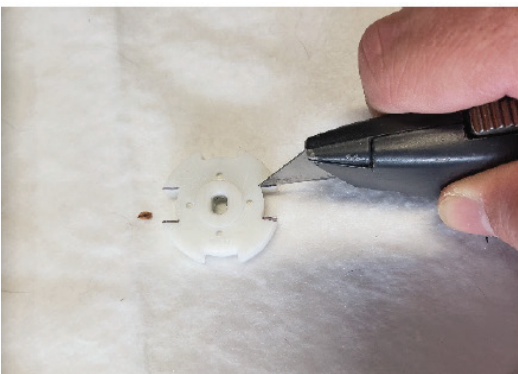

SECTION E | ROMANS

2.) Remove the Skyline adapter and install the R8 bracket adapter included with the motor

a. Do not install the screws



Performing the Retrofit:

1.) Line up the end cap onto the motor head and Mark the 3 holes to be drilled

a. ENSURE THE P1 BUTTON IS POINTED DOWN

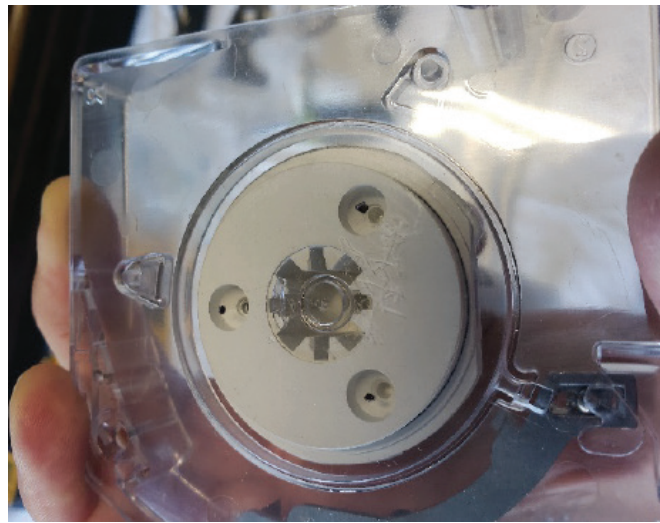

2.) Utilizing a counter sink bit, drill 3 holes

3.) Secure the end cap to the motor head

4.) Install the Crown and Drive

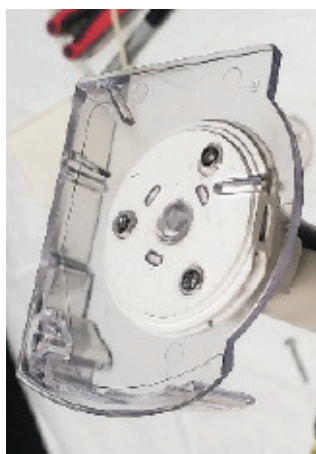
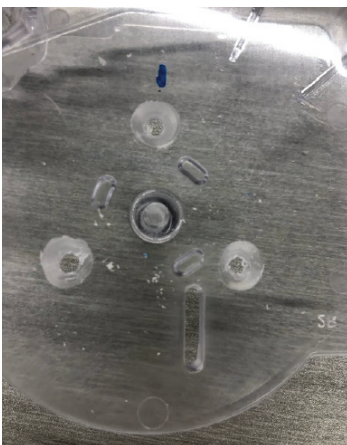

SECTION E | ROMANS

Install the Motor and end cap screw/cover:

1.) *PAIR THE SHADE TO THE REMOTE AND UTILIZE THE MICRO ADJUSTMENTS TO LINE THE DRIVE INTO THE TUBE WITHOUT HAVING TO ROTATE THE END CAP



Idler end adjustment

1.) Remove Idler end Screw and remove end cap with idler attached



2.) Remove limiter ring

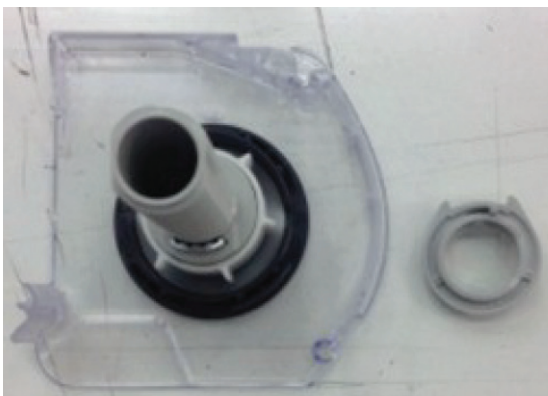

3.) Re-Install the idler end cap.



Pass through Tilt Motor Retrofit – Horizontal Blind

Tools and Parts needed:

- Flathead Screwdriver
- Pliers
- Exacto/Box Cutter
- Passthrough Tilt Motor Kit:
 - Motor/Cradle
 - Switch
 - Battery
 - Shaft Adapters

Pass through Tilt Motor Retrofit – Horizontal Blind



- Notate where the manual tilt control mechanism is, as we will be removing it

Assess the headrail:

- Notice the cordless lift mechanism above the tilt control shaft.
- Remove the cordless lift mechanism being cautious of the plastic pieces securing it to the end caps.



Prepare the Motor

Tools and Parts needed:

- We will be removing the motor from the cradle of easier installation into the headrail
- This tilt mechanism sits lower than a standard tilting shaft
 - Remove the feet of the cradle with a box cutter
- Install the appropriate shaft adapter



Prepare the Retrofit

1. Remove the Tilting shaft
2. Remove the manual tilt control mechanism
3. Install the Switch
 - Test fit before removing the tape film
 - Slide the cables (will run to motor and battery) under the ladder to keep the headrail clean
4. Install the cradle
5. Install the motor
 - Plug in and insert proper shaft adapter
6. Install the battery
7. Re-insert the tilting rod
 - Ensure all ladder spools aligned!

Perform the Retrofit

1.



5.



2.



5a.



3.



6.

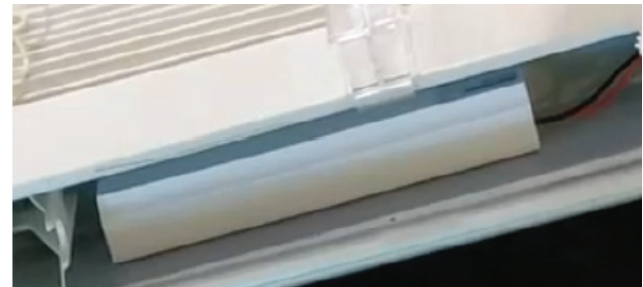

3a.



7.



4.



NOTES

A series of horizontal dotted lines for taking notes.



AUTOMATE™

A DIVISION OF **ROLLEASE ACMEDA**

FOLLOW US



Follow Rollease Acmeda on social media with:
[**@ROLLEASEACMEDA**](#)

© 2021 Copyright Rollease Acmeda Group